



User Guide

***SI-Ethernet and
Unidrive M -
Onboard Ethernet***

Part Number: 0478-0137-01
Issue: 1

General Information

The manufacturer accepts no liability for any consequences resulting from inappropriate, negligent or incorrect installation or adjustment of the optional parameters of the equipment or from mismatching the variable speed drive with the motor.

The contents of this guide are believed to be correct at the time of printing. In the interests of commitment to a policy of continuous development and improvement, the manufacturer reserves the right to change the specification of the product or its performance, or the content of the guide without notice.

All rights reserved. No parts of this guide may be reproduced or transmitted in any form or by any means, electrical or mechanical including, photocopying, recording or by an information storage or retrieval system, without permission in writing from the publisher.

Environmental Statement

Control Techniques is committed to minimising the environmental impacts of its manufacturing operations and of its products throughout their life cycle. To this end, we operate an Environmental Management System (EMS) which is certified to the International Standard ISO 14001. Further information on the EMS, our Environment Policy and other relevant information is available on request, or can be found at www.greendrives.com.

The electronic variable speed drives manufactured by Control Techniques have the potential to save energy and (through increased machine/process efficiency) reduce raw material consumption and scrap throughout their long working lifetime. In typical applications, these positive environmental effects far outweigh the negative impacts of product manufacture and end-of-life disposal.

Nevertheless, when the products eventually reach the end of their useful life, they must not be discarded but should instead be recycled by a specialist recycler of electronic equipment. Recyclers will find the products easy to dismantle into their major component parts for efficient recycling. Many parts snap together and can be separated without the use of tools, while other parts are secured with conventional fasteners. Virtually all parts of the product are suitable for recycling.

Product packaging is of good quality and can be re-used. Large products are packed in wooden crates, while smaller products come in strong cardboard cartons which themselves have a high-recycled fibre content. If not re-used, these containers can be recycled. Polythene, used on the protective film and bags from wrapping product, can be recycled in the same way. Control Techniques' packaging strategy prefers easily recyclable materials of low environmental impact, and regular reviews identify opportunities for improvement.

When preparing to recycle or dispose of any product or packaging, please observe local legislation and best practice.

Firmware Statement

This product is supplied with the latest firmware version. When retro-fitting to an existing system, all firmware versions should be verified to confirm the same functionality as products of the same type already present. This also applies to products returned from a Control Techniques Service Centre or Repair Centre. If there is any doubt please contact the supplier of the product.

The firmware version of the product can be identified by looking at Pr **MM.002** where **MM** is the relevant menu number for the module slot being used.

REACH legislation

EC Regulation 1907/2006 on the Registration, Evaluation, Authorisation and restriction of Chemicals (REACH) requires the supplier of an article to inform the recipient if it contains more than a specified proportion of any substance which is considered by the European Chemicals Agency (ECHA) to be a Substance of Very High Concern (SVHC) and is therefore listed by them as a candidate for compulsory authorisation.

For current information on how this requirement applies in relation to specific Control Techniques products, please approach your usual contact in the first instance. Control Techniques position statement can be viewed at:

<http://www.controltechniques.com/REACH>

Copyright : © August 2014 Control Techniques Ltd.

Issue : 1

Firmware: V01.03.00.54

Contents

1	Safety information	5
1.1	Warnings, cautions and notes	5
1.2	Electrical safety - general warning	5
1.3	System design and safety of personnel	5
1.4	Environmental limits	5
1.5	Compliance with regulations	6
1.6	Motor	6
1.7	Adjusting parameters	6
1.8	General safety considerations for remote operation	6
2	Introduction	7
2.1	Products covered by this User Guide	7
2.2	Features	7
2.3	Option module identification	8
2.4	Product conformance	8
2.5	Conventions used in this guide	9
3	Mechanical installation	10
4	Electrical installation	12
4.1	SI-Ethernet module information	12
4.2	Cabling considerations	12
4.3	Module grounding	12
4.4	Cable shield connections	13
4.5	Cable	13
4.6	Maximum network length	13
4.7	Network topology	13
5	Getting started	15
5.1	Network design considerations	15
5.2	Addressing	15
5.3	Where do IP addresses come from?	15
5.4	Addressing etiquette	15
5.5	Class types	16
5.6	Generating the complete address	17
5.7	DHCP considerations	18
5.8	Basic principles of routing	18
5.9	Set-up flow chart	19
5.10	Single line parameter descriptions	20
6	Parameters	38
6.1	Menus	38
7	Key features and Protocols	119
7.1	PC/PLC considerations	119
7.2	Modbus TCP/IP	119
7.3	RTMoE (Real Time Motion over Ethernet)	129
7.4	Non-cyclic data access	138
7.5	EtherNet/IP	144

8	PC Tools Applications	179
8.1	Unidrive M Connect	179
8.2	Machine Control Studio	179
8.3	CTScope	180
8.4	SyPTPro	180
8.5	CT OPC server	181
9	Security	182
9.1	Introduction	182
9.2	General site security issues	182
9.3	Default restrictions	182
10	Diagnostics	183
10.1	LED diagnostics	183
10.2	Drive trip display codes	183
10.3	Ethernet sub trip codes	184
10.4	Ethernet sub trip codes	186
10.5	Ethernet hardware fault trip codes	186
10.6	Diagnostic flow chart	188
11	Glossary of terms	189

1 Safety information

1.1 Warnings, cautions and notes



A **Warning** contains information, which is essential for avoiding a safety hazard.



A **Caution** contains information, which is necessary for avoiding a risk of damage to the product or other equipment.

NOTE A **Note** contains information, which helps to ensure correct operation of the product.

1.2 Electrical safety - general warning

The voltages used in the drive can cause severe electrical shock and/or burns, and could be lethal. Extreme care is necessary at all times when working with or adjacent to the drive. Specific warnings are given at the relevant places in this User Guide.

1.3 System design and safety of personnel

The drive is intended as a component for professional incorporation into complete equipment or a system. If installed incorrectly, the drive may present a safety hazard.

The drive uses high voltages and currents, carries a high level of stored electrical energy, and is used to control equipment which can cause injury.

Close attention is required to the electrical installation and the system design to avoid hazards, either in normal operation or in the event of equipment malfunction. System design, installation, start up and maintenance must be carried out by personnel who have the necessary training and experience. They must read this safety information and this User Guide carefully.

The STOP and SAFE TORQUE OFF functions of the drive do not isolate dangerous voltages from the output of the drive or from any external option unit. The supply must be disconnected by an approved electrical isolation device before gaining access to the electrical connections.

With the sole exception of the SAFE TORQUE OFF function, none of the drive functions must be used to ensure safety of personnel, i.e. they must not be used for safety-related functions.

The SAFE TORQUE OFF function may be used in a safety-related application. The system designer is responsible for ensuring that the complete system is safe and designed correctly according to the relevant safety standards.

1.4 Environmental limits

Instructions regarding transport, storage, installation and use of the drive must be complied with, including the specified environmental limits. Drives must not be subjected to excessive physical force.

For more information on these limits see the relevant drive user guide.

1.5 Compliance with regulations

The installer is responsible for complying with all relevant regulations, such as national wiring regulations, accident prevention regulations and electromagnetic compatibility (EMC) regulations. Particular attention must be given to the cross-sectional areas of conductors, the selection of fuses or other protection, and protective earth (ground) connections.

For instructions in achieving compliance with specific EMC standards, please refer to the relevant drive user guide.

Within the European Union, all machinery in which this product is used, must comply with the directives stated in the relevant drive user guide.

1.6 Motor

Ensure the motor is installed in accordance with the manufacturer's recommendations. Ensure the motor shaft is not exposed.

Standard squirrel cage induction motors are designed for single speed operation. If it is intended to use the capability of the drive to run a motor at speeds above its designed maximum, it is strongly recommended that the manufacturer is consulted first.

Low speeds may cause the motor to overheat because the cooling fan becomes less effective. The motor should be installed with a protection thermistor. If necessary, an electric forced vent fan should be used.

The values of the motor parameters set in the drive affect the protection of the motor. The default values in the drive should not be relied upon.

It is essential that the correct value is entered in the motor rated current parameter Pr **00.046**, as this affects the thermal protection of the motor.

1.7 Adjusting parameters

Some parameters have a profound effect on the operation of the drive. They must not be altered without careful consideration of the impact on the controlled system. Measures must be taken to prevent unwanted changes due to error or tampering especially if a remote user can access the drive over Ethernet.

1.8 General safety considerations for remote operation

The Ethernet interface enables the possibility of remotely controlling a machine from a distance. It is vital that when connecting to a machine remotely, adequate safety procedures are implemented to prevent damage to the machine or injury to personnel.

Any connection to a "live" system has the possibility of altering the state of the machine, adequate procedures must be implemented to cover this situation.

It is the responsibility of the machine builder to ensure that such a system is safe and complies with current legislation.

2 Introduction

2.1 Products covered by this User Guide

This User Guide covers the SI-Ethernet option module and the onboard factory installed Ethernet interface. Both the SI-Ethernet module and the onboard Ethernet interface offer the same functionality.

The onboard Ethernet interface provides Ethernet connectivity and is installed during manufacture to the following drives:

- Unidrive M700
- Unidrive M702

The SI-Ethernet is an option module that provides Ethernet connectivity and can be installed to the following drives:

- Unidrive M200 / M201 (sizes 2 to 6)
- Unidrive M300 (sizes 2 to 6)
- Unidrive M400 (sizes 2 to 8)
- Unidrive M600 (sizes 3 to 8)
- Unidrive M700 / M701 / M702 (sizes 3 to 10)
- Unidrive M800 / M810 (sizes 3 to 8)

2.2 Features

The following list gives an overview of the functionality available:

- Single RJ45 connectivity with support for shielded twisted pair.
- 100 Mbs Ethernet with auto-negotiation.
- Full and half duplex operation with auto-negotiation.
- Auto crossover detection.
- TCP/IP.
- Modbus TCP/IP.
- EtherNet/IP.
- Switch or Gateway mode.
- VLAN tagging.
- SyPTPro over Ethernet.
- Unidrive M Connect over Ethernet.
- Machine Control Studio.
- Static IP configuration or DHCP client.
- Non-cyclic data transfer with user program.
- Up to 3 transmit and 3 receive cyclic links (easy mode).
- IEEE1588 Precision Time Protocol synchronization.
- RTMoE (Real Time Motion over Ethernet).

2.2.1 Backup/auxiliary supply

Some drives provide a method of powering up the control circuits (and therefore any option module installed) if the AC supply is removed, this allows Ethernet communication to continue operating when the main AC supply is switched off.

Safety information
Introduction
Mechanical installation
Electrical installation
Getting started
Parameters
Key features and Protocols
PC Applications
Security
Diagnostics
Glossary of terms
Index

2.3 Option module identification

Figure 2-1 SI-Ethernet

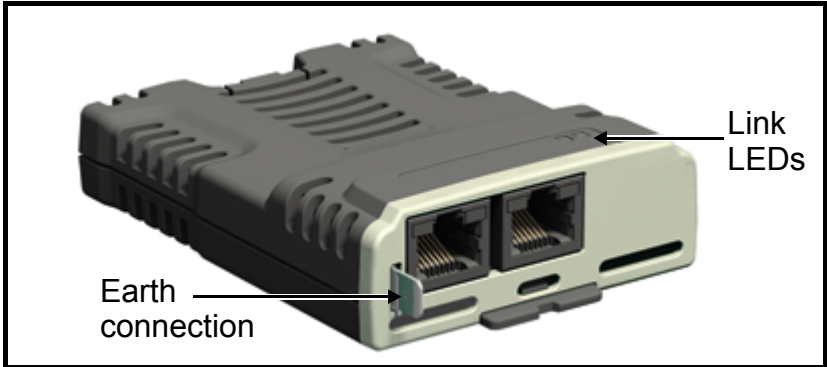

The SI-Ethernet can be identified by:

1. The label located on the topside of the option module.
2. The color coding across the front of the option module. SI-Ethernet being beige.

Figure 2-2 SI-Ethernet label

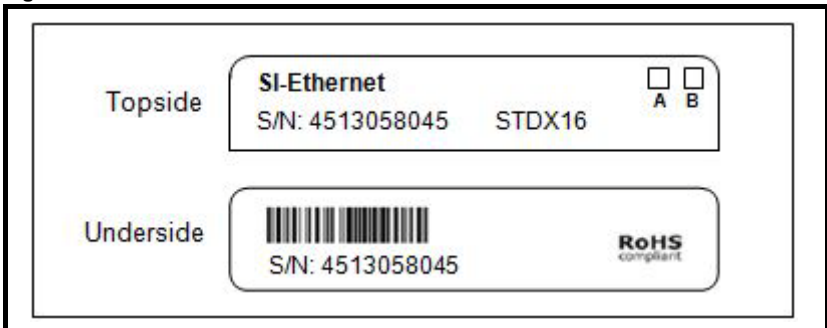

1. Topside module label
2. Underside module label. The color coding being beige.

2.3.1 Date code format

The date code is split into two sections: a letter followed by a number. The letter indicates the year, and the number indicates the week number (within the year) in which the option module was built. The letters start with A for 1991 (B for 1992, C for 1993 etc.).

Example: A date code of W31 would correspond to week 31 of year 2013.

2.4 Product conformance

The Ethernet interface complies with IEEE 802.3 and meets the isolation requirements of safety standard EN50178:1998.

2.5 Conventions used in this guide

The configuration of the host drive and option module is done using menus and parameters. A menu is a logical collection of parameters that have similar functionality.

In the case of an option module, the option module set-up parameters in menu 0 will appear in drive menu 15, 16 or 17 depending on which slot the module is installed in. In the case of the onboard Ethernet interface, the set-up parameters in menu 0 will appear in drive menu 24.

The setting of the Option Slot Identifiers (Pr **11.056**) may change the slot numbering from those described above. The internal menus of the option module or onboard Ethernet interface will appear before menu 0 and after menu 41.

NOTE

For M200, M300 and M400 drives, the option module set-up parameters will appear in menu 15.

The method used to determine the menu or parameter is as follows:

- Pr **S.mm.ppp** - Where **S** signifies the option module slot number and **mm.ppp** signifies the menu and parameter number respectively.
If the option module slot number is not specified then the parameter reference will be a drive parameter.
- Pr **MM.ppp** - Where **MM** signifies the menu allocated to the option module setup menu and **ppp** signifies the parameter number within the set-up menu.
- Pr **mm.000** - Signifies parameter number 000 in any drive menu.

3 Mechanical installation



CAUTION: power down the drive before installing / removing option modules. Failure to do so may result in damage to the product. Refer to the relevant *Safety Information* section in the appropriate drive manual.

Figure 3-1 Installation of an SI option module on Unidrive M200 to M400 (sizes 2 to 4)

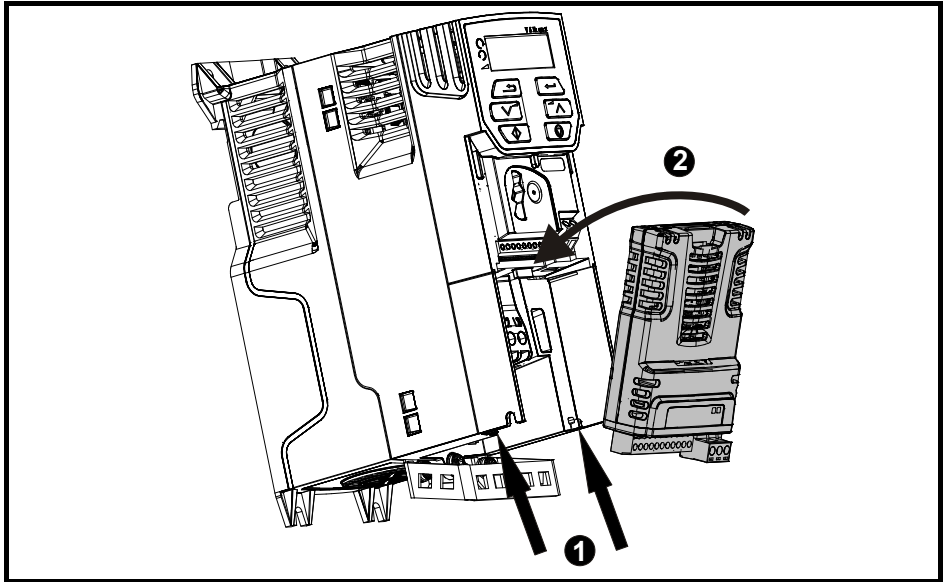

- With the option module tilted slightly backwards, align and locate the two holes in the rear of the option module onto the two tabs (1) on the drive.
- Place the option module onto the drive as shown in (2) until the module clicks into place. The terminal cover on the drive holds the option module in place, so this must be put back on.

NOTE Option modules can only be installed on drives that have the option module slot functionality.

NOTE Figure 3-1 above is for illustration only, the actual option module may be different to the one shown.

Figure 3-2 Installation of an SI option module on Unidrive M200 to M400 (sizes 5 to 8)

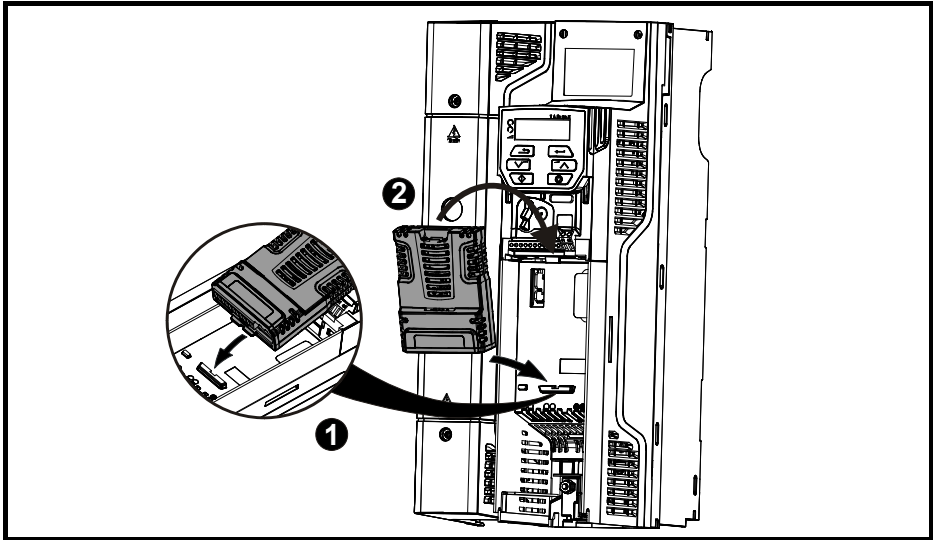

- Place the option module onto the drive as shown in (2) until the module clicks into place. The terminal cover on the drive holds the option module in place, so this must be put back on.

Figure 3-3 Installation of an SI option module on Unidrive M600 to M810

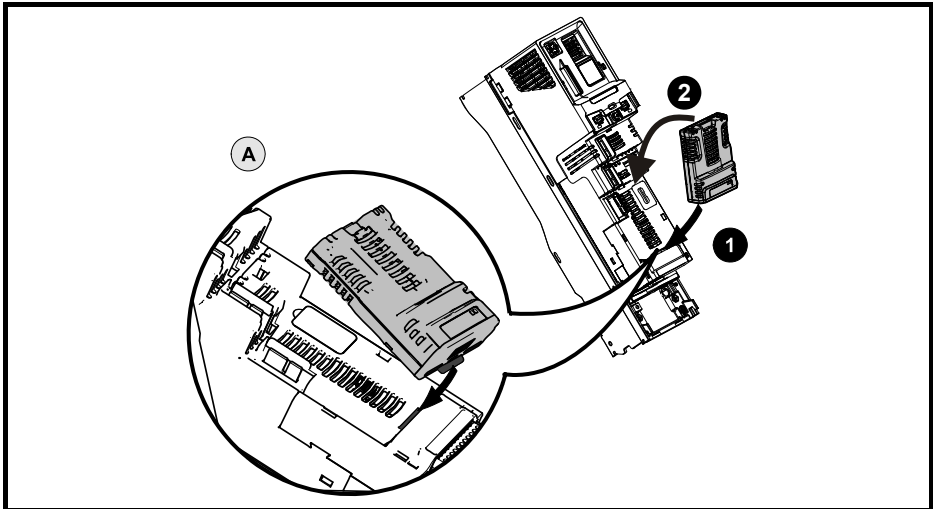

- Move the option module in direction shown (1/2).
- Align and insert the option module tab in to the slot provided, this is highlighted in the detailed view (A).
- Press down on the option module until it clicks into place.

NOTE Option module slots must be used in the following order: Slot 3 (lower), Slot 2 (middle) and then Slot 1(upper).

Safety information
Introduction
Mechanical installation
Electrical installation
Getting started
Parameters
Key features and Protocols
PC Applications
Security
Diagnostics
Glossary of terms
Index

4 Electrical installation

4.1 SI-Ethernet module information

SI-Ethernet provides two standard RJ45 UTP/STP (*Un-shielded/Shielded Twisted Pair*) connections to a 100 Mbs Ethernet system. In addition to the RJ45 connectors, a grounding tag is supplied for supplementary bonding. SI-Ethernet provides 2 diagnostic LEDs for status and information purposes located on the module topside.

Figure 4-1 SI-Ethernet

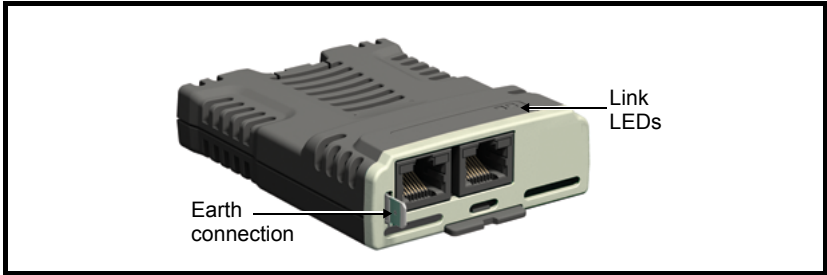

Figure 4-1 shows an overview of the module connections and indicators.

Figure 4-2 Ethernet connections

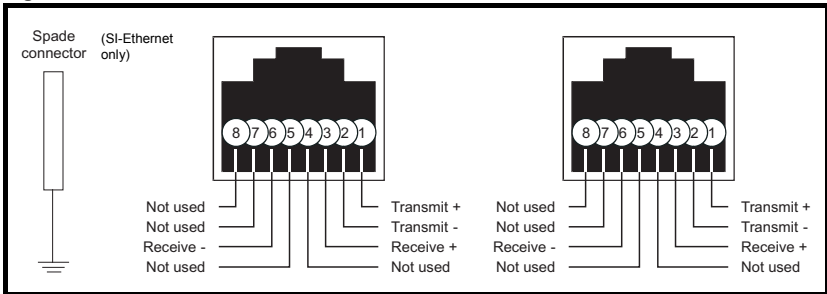

Figure 4-2 shows the electrical connections of the RJ45 connector.

NOTE

On the onboard Ethernet interface, pin1 is located on the left but on the SI-Ethernet module pin 1 is located on the right (as shown).

4.2 Cabling considerations

To ensure long-term reliability it is recommended that any cables used to connect a system together are tested using a suitable Ethernet cable tester, this is of particular importance when cables are constructed on site.

Any isolated signal circuit has the capability to become live through accidental contact with other conductors; as such they should always be double-insulated from live parts. The routing of network and signal wires should be done so as to avoid close proximity to mains voltage cabling.

4.3 Module grounding

SI-Ethernet is supplied with a grounding tag on the module that should be connected to the closest possible grounding point using the minimum length of cable. This will greatly improve the noise immunity of the module.

4.4 Cable shield connections

Standard Ethernet UTP or STP cables do not require supplementary grounding.

4.5 Cable

It is recommended that a minimum specification of CAT5e is installed on new installations, as this gives a good cost/performance ratio. If you are using existing cabling, this may limit the maximum data rate depending on the cable ratings. In noisy environments, the use of STP or fiber optic cable will offer additional noise immunity.

NOTE

Cabling issues are the single biggest cause of network down-time. Ensure cabling is correctly routed, wiring is correct, connectors are correctly installed and any switches or routers used are rated for industrial use. Office grade Ethernet equipment does not generally offer the same degree of noise immunity as equipment intended for industrial use.

4.6 Maximum network length

The main restriction imposed on Ethernet cabling is the length of a single segment of cable as detailed in Table 4.1. If distances greater than this are required it may be possible to extend the network with additional switches or by using a fiber optic converter.

Table 4.1 Ethernet maximum network lengths

Type Of Cable	Data rate (bit/s)	Maximum trunk length (m)
Copper - UTP/STP CAT 5	100 M	100
Fiber Optic - Multi-mode		3000
Fiber Optic - Single-mode		up to 100000

NOTE

The distances specified are absolute recommended maximums for reliable transmission of data. The distances for the fiber optic sections will be dependent on the equipment used on the network. The use of wireless networking products is not recommended for control systems, as performance may be affected by many external influences.

4.7 Network topology

The SI-Ethernet option module and onboard Ethernet interface support multiple network topologies this allows the user to design a robust network using the topology that works best for the chosen design.

Star topology:

- Enables individual devices to be swapped out
- Minimise message transmission delays

Line topology (daisy chain):

- Simple wiring
- Lowest cost

Tree topology:

- Maximises bandwidth - contains messages within appropriate segments
- Products can be connected in functional groups, e.g. to enable one section of a machine to be turned off

Figure 4-3 Typical network topologies

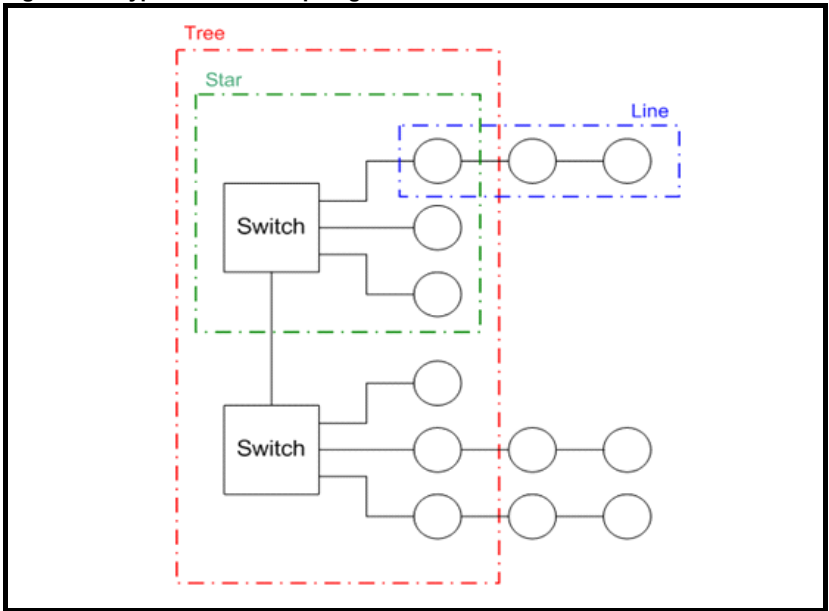

5 Getting started

5.1 Network design considerations

Ethernet is an open system allowing many different vendors to design and supply equipment. When designing an industrial network you must carefully consider the topology and data traffic on the network to avoid potential problems.

To avoid bandwidth issues it is recommended that the control network is logically separate from any other network. Where possible a physically separate network should be used. If this is not possible, the use of managed network devices should be considered to prevent unnecessary traffic such as broadcasts reaching the control network.

NOTE The use of un-switched hubs is not supported.

5.2 Addressing

The addressing system used on Ethernet uses two essential numbers for making connection, these are the IP address and the subnet mask. The address allows a specific device to be located and the subnet mask defines how many bits represent the subnet part of the address and how many bits represent the node address (*see section 5.6.1 The IP address on page 17*). Generally devices on different subnets can only communicate by using a gateway (*typically a router or firewall*).

5.3 Where do IP addresses come from?

Every address on a network must be unique. If you do not connect your network to any other networks the assignment of IP addresses is not critical (*although using a standard system is recommended*), as you have full control of the addresses used. The issue of addressing becomes important when connecting multiple networks together or connecting to the Internet where there is a strong possibility of duplication of addresses if a scheme is not followed.

5.4 Addressing etiquette

The following list details some points that should be considered when selecting addresses:

- **Reserve address space:** Ensure you have enough reserve address space on your chosen addressing scheme to allow for future expansion.
- **Uniqueness:** Ensure your addresses are unique, every device on a subnet must have a unique address.
- **Avoid reserved addresses:** For example the address 127.0.0.1 is reserved as the loop back address.
- **Broadcast and system addresses:** The highest and lowest host address on a subnet are reserved addresses.
- **Use a system:** Have a scheme for assigning your addresses, for example typically servers may have a low IP address and routers a high IP address. It is not necessary to allocate consecutive IP addresses so it is possible to reserve ranges for specific uses such as servers, work stations or routers.

Safety information
Introduction
Mechanical installation
Electrical installation
Getting started
Parameters
Key features and Protocols
PC Applications
Security
Diagnostics
Glossary of terms
Index

5.5 Class types

IP addresses are grouped into ranges called classes, each class has a specific set of addresses and has a typical situation where it is used.

When selecting the class of IP address required, consideration must be given to how many subnets you need, how many hosts are required and if you will need a public (*worldwide*) or a private (*local*) addressing scheme. Table 5.1 shows an overview of how the class types are defined and Table 5.2 shows how each class separates the subnet and host ID.

Table 5.1 Subnets and hosts supported by class type

Address Class	First Octet Decimal Range	Number of Subnets	Number of Hosts
A	1-126.x.y.z	126	16,777,214
B	128-191.x.y.z	16,382	65,534
C	192-223.x.y.z	2,097,150	254

Table 5.2 Address components

Address Class	IP Address	Subnet Component	Host Component
A	w.x.y.z	w	x.y.z
B	w.x.y.z	w.x	y.z
C	w.x.y.z	w.x.y	z

NOTE

Using the subnet mask it is possible to modify the IP addressing such that the ratio of subnets and host addresses may be changed. This gives you the facility to “adjust” standard classes to suit your specific requirements.

5.5.1 Class A addresses

A class A address only uses the first octet to represent the subnet, the remaining octets are used to represent the host id. These addresses are intended for large organisations such as universities and the military. These addresses must be requested from the governing body (*InterNIC*) when using them publicly (*on the Internet*) to avoid duplication.

5.5.2 Class B addresses

A class B address uses the first two octets to represent the subnet, the remaining octets are used to represent the host id. These addresses are intended for medium to large size networks. These addresses must be requested from the governing body (*InterNIC*) when using them publicly (*on the Internet*) to avoid duplication. Class B addresses are generally used on public or private networks.

5.5.3 Class C addresses

Class C addresses use the first 3 octets as the subnet address and the remaining octet as the host id. A class C address is normally used on a private network only, due to the restriction on the number of hosts on the network. Class C addresses will not be routed onto the Internet.

5.5.4 Class D & E addresses

These addresses are reserved for multicasting and experimental use.

5.6 Generating the complete address

A complete IP address consists of an IP address and a subnet mask, these two numbers are required to allow communication on Ethernet using TCP/IP.

5.6.1 The IP address

The IP address is made up from four 8 bit decimal numbers (*octets*) and is written as follows:

w.x.y.z for example 192.168.0.1 (*class c*)

5.6.2 The subnet mask

The subnet mask defines what part of the address constitutes the subnet within the IP address and what part of the address constitutes the host address. The subnet mask is bit-wise ANDed with the address to give the subnet to which the host belongs. A typical class C subnet mask would be 255.255.255.0, this may alternatively be written as '/24' as in the example below, showing an IP address of 192.168.0.1 with a subnet mask of 255.255.255.0. This alternative notation indicates the number of bits representing the subnet part of the address, starting from the most significant bit.

Alternative subnet mask notation: 192.168.0.1 /24

5.6.3 Completing the address

To determine which part of the address constitutes the network address and which part constitutes the node address, the IP address is bit-wise ANDed with the subnet mask. Figure 5-1 shows how the IP address and subnet mask are used to determine the subnet address and the host address.

Figure 5-1 Completing the address

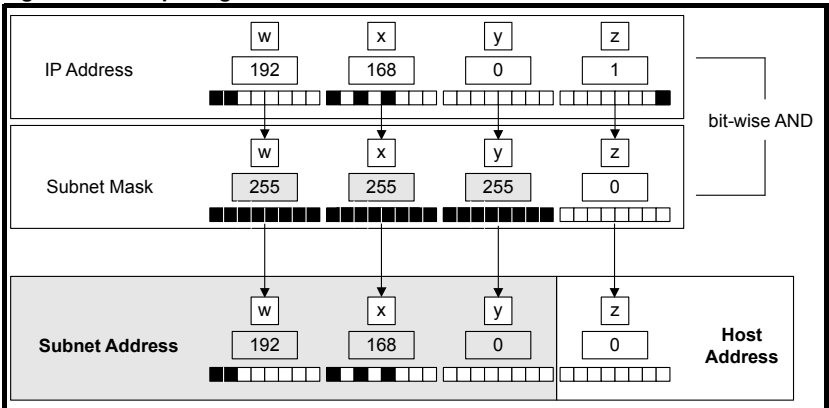

5.7 DHCP considerations

5.7.1 Using fixed IP addressing

Using fixed IP addresses (*manually configured*) means that if a module fails, the IP address can be restored to a replacement module without the need to reconfigure the DHCP server. Using fixed addresses also prevents the DHCP server from changing the address. When using fixed IP addresses, it is vital that the IP address is reserved on the DHCP server to prevent duplicate addressing.

NOTE If using manual IP address configuration please note that the IP address subnet mask and the default gateway must also be set manually. For more information on manual configuration see section 7.2.6 *Network* on page 22.

5.7.2 Using DHCP

If DHCP is used, it is recommended that the allocated IP address is bound to the MAC address of the Ethernet interface, this strategy prevents the IP address changing on the Ethernet interface. Any leased addresses should be leased permanently to prevent IP address changes.

NOTE If the SI-Ethernet module is configured to use DHCP and the module requires exchanging, the new SI-Ethernet module will have a different MAC address and hence the DHCP server will issue the new module with a different IP address.

5.8 Basic principles of routing

Routing is required to get TCP/IP packets from one subnet to another. In an IP network, nodes from one subnet cannot communicate directly with nodes on a different subnet. To allow nodes to communicate, a router (*or similar device*) is required to allow the two subnets to exchange data. This means that any node wishing to communicate with a node that is not on its own subnet, must know the address of a router that is on its own subnet. This is sometimes called a gateway or default gateway.

5.9 Set-up flow chart

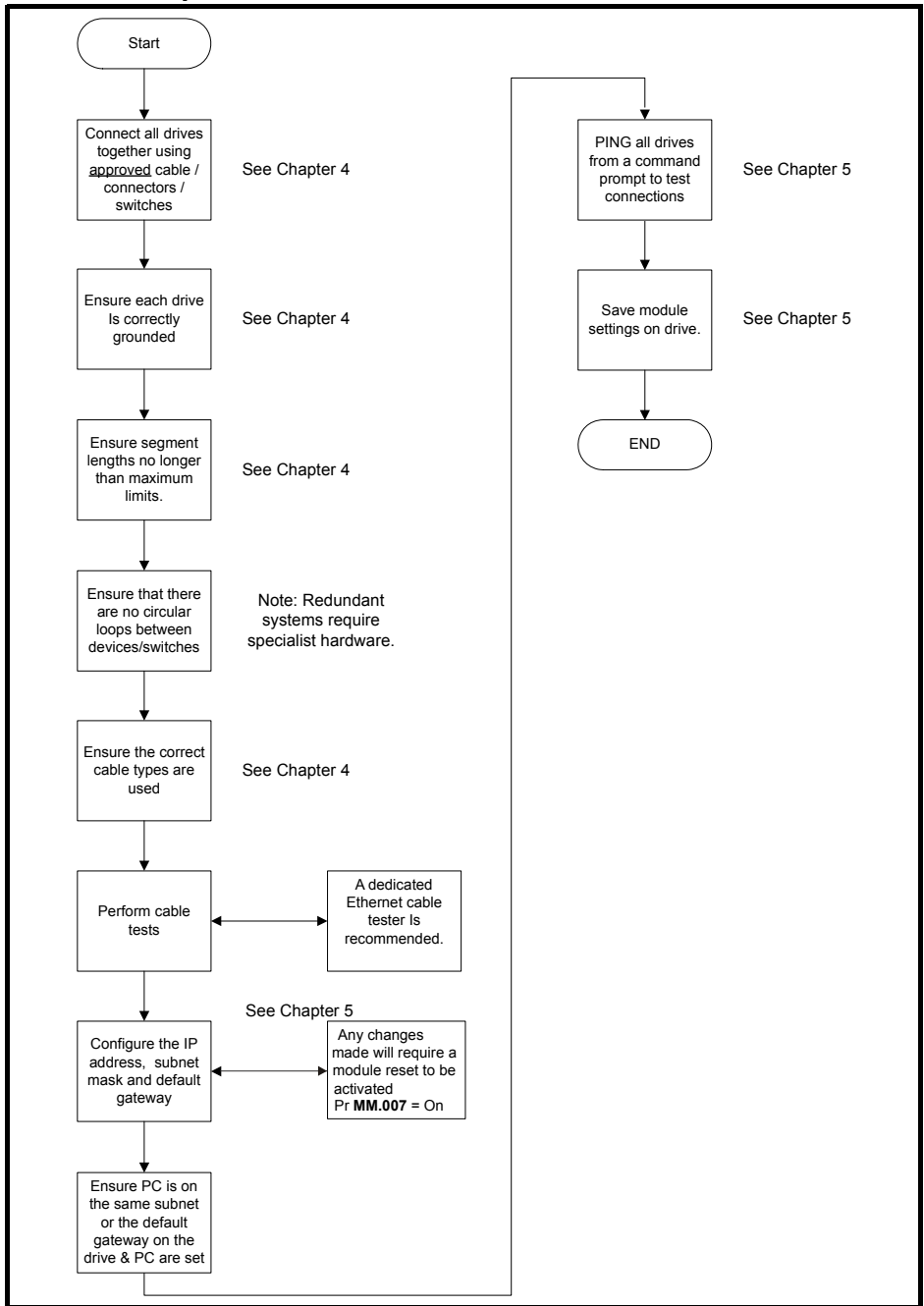

Safety information
Introduction
Mechanical installation
Electrical installation
Getting started
Parameters
Key features and Protocols
PC Applications
Security
Diagnostics
Glossary of terms
Index

5.10 Single line parameter descriptions

Table 5.3 lists the coding used for the parameter type in the subsequent parameter description tables.

Table 5.3 Parameter type coding

RW	Read / Write	RO	Read-only	Bit	Bit parameter	Txt	Text string	Date	Date parameter	Time	Time parameter
Chr	Character parameter	Bin	Binary parameter	IP	IP address	Mac	MAC address	Ver	Version number	SMP	Slot, menu, parameter
Num	Number parameter	DE	Destination	ND	No default value	RA	Rating dependent	NC	Non-copyable	PT	Protected
FI	Filtered	US	User save	PS	Power-down save						

5.10.1 Menu 0 - Ethernet set-up (MM.ppp)

Table 5.4 Menu 0 parameters

Parameter		Range	Default	Type					
00.001	Module ID	0 to 65535		RO	Num	ND	NC	PT	
00.002	Software Version	00.00.00.00 to 00.99.99.99		RO	Ver	ND	NC	PT	
00.003	Hardware Version	0.00 to 99.99		RO	Num	ND	NC	PT	
00.004	Serial Number LS	00000000 to 99999999		RO	Num	ND	NC	PT	
00.005	Serial Number MS	0 to 99999999		RO	Num	ND	NC	PT	
00.006	Status	Bootldr - Update (-2), Bootldr - Idle (-1), Initializing (0), OK (1), Config (2), Error (3)		RO	Txt	ND	NC	PT	
00.007	Reset	Off (0) or On (1)	Off (0)	RW	Bit		NC		
00.008	Default	Off (0) or On (1)	Off (0)	RW	Bit		NC		
00.009	Active Alarm Bits	0000000000000000 to 1111111111111111	0000000000000000	RO	Bin		NC		
00.010	Active IP Address	128.0.0.0 to 127.255.255.255	0.0.0.0	RO	IP		NC	PT	

Menu 0 within the Ethernet interface, is also displayed in the drive menu 15, 16, 17 or 24 depending on which slot the option module is installed to and the setting of the Option Slot Identifiers parameter (**S.11.056**).

By default, the SI-Ethernet option module will be either menu 15, 16 or 17 and the onboard Ethernet interface will be menu 24.

Table 5.5 *Menu 0 slot availability* details the drive models and their available slots and associated drive menus for use with both the SI-Ethernet option module and the onboard Ethernet interface.

Table 5.5 Menu 0 slot availability

Drive model	Module	Slot number	Drive menu (MM)
M200 / M201 / M300 / M400	SI-Ethernet	1	15
		2	N/A
		3	N/A
	Onboard Ethernet	4	N/A
M600	SI-Ethernet	1	15
		2	16
		3	17
	Onboard Ethernet	4	N/A
M700 / M702	SI-Ethernet	1	15
		2	16
		3	17
	Onboard Ethernet	4	24
M701	SI-Ethernet	1	15
		2	16
		3	17
	Onboard Ethernet	4	N/A
M800 / M810	SI-Ethernet	1	15
		2	16
		3	N/A
	Onboard Ethernet	4	24

Safety information
Introduction
Mechanical installation
Electrical installation
Getting started
Parameters
Key features and Protocols
PC Applications
Security
Diagnostics
Glossary of terms
Index

5.10.2 Menu 2 - Ethernet Configuration

Table 5.6 Menu 2 parameters

Parameter		Range	Default	Type					
02.003	Network Status	Initializing (0), Links Down (1), DHCP In Progress (2), No Address (3), Ready (4), Active (5)		RO	Txt	ND	NC	PT	
02.004	Network Message Count	0 to 65535 Messages/s		RO	Num	ND	NC	PT	
02.005	DHCP Enable	Off (0) or On (1)	On (1)	RW	Bit				US
02.006	IP Address	0.0.0.0 to 255.255.255.255	192.168.1.100	RW	IP				US
02.007	Subnet Mask	0.0.0.0 to 255.255.255.255	255.255.255.0	RW	IP				US
02.008	Default Gateway	0.0.0.0 to 255.255.255.255	192.168.1.254	RW	IP				US
02.009	Primary DNS	0.0.0.0 to 255.255.255.255	0.0.0.0	RW	IP				US
02.010	Secondary DNS	0.0.0.0 to 255.255.255.255	0.0.0.0	RW	IP				US
02.011	MAC Address	00:00:00:00:00:00 to FF:FF:FF:FF:FF:FF		RO	Mac	ND	NC	PT	
02.020	Priority Protocol	None (0), Modbus TCP (1), EtherNet/IP (2)	None (0)	RW	Txt				US
02.021	Web Server Enable	Off (0) or On (1)	On (1)	RW	Bit				US
02.022	Web Server Port	0 to 65535	80	RW	Num				US
02.024	Ethernet MTU	158 to 1500 Bytes	1500 Bytes	RW	Num				US
02.025	Gateway Mode	Switch (0), Gateway (1), Strict Gateway (2)	Switch (0)	RW	Txt				US
02.030	VLAN Enable	Off (0) or On (1)	Off (0)	RW	Bit				US
02.031	Drive VLAN ID	0 to 255	0	RW	Num				US
02.035	Non cyclic enable	Off (0) or On (1)	Off (0)	RW	Bit				US
02.036	Non cyclic base parameter	0.00.000 to 0.59.999	0.00.000	RW	SMP				US

5.10.3 Menu 9 - Ethernet Resources

Table 5.7 Menu 9 parameters

Parameter		Range	Default	Type					
09.001	Cyclic Tx Links Free	0 to 255		RO	Num	ND	NC		
09.002	Cyclic Rx Links Free	0 to 255		RO	Num	ND	NC		
09.003	Fieldbus Links Free	0 to 255		RO	Num	ND	NC		
09.004	Cyclic Mappings Free	0 to 255		RO	Num	ND	NC		
09.008	Background cycles per second	0 to 65535		RO	Num	ND	NC	PT	
09.010	Synchronous Task % Free	0 to 255 %		RO	Num	ND	NC		
09.020	Synchronous Task Worst % Free	0 to 255 %		RO	Num	ND	NC		
09.030	PCB Temperature	-128 to 127 ° C		RO	Num	ND	NC		

5.10.4 Menu 10 - Easy Mode Cyclic Data

Table 5.8 Menu 10 parameters

Parameter		Range	Default	Type					
10.001	Enable	Off (0) or On (1)	On (1)	RW	Bit				US
10.002	Reset	Off (0) or On (1)	Off (0)	RW	Bit		NC		
10.003	Default	Off (0) or On (1)	Off (0)	RW	Bit		NC		
10.010	Tx1 Link Profile	Std (0), Sync (1)	Std (0)	RW	Txt				US
10.011	Tx1 Link Number	0 to 255	0	RW	Num				US
10.012	Tx1 Source Parameter	0.00.000 to 4.99.999	0.00.000	RW	SMP			PT	US
10.013	Tx1 Parameter Count	0 to 10	0	RW	Num				US
10.014	Tx1 Link Transmission Type	Unicast (0), Broadcast (1), Multicast1 (2), Multicast2 (3), Multicast3 (4), Multicast4 (5)	Unicast (0)	RW	Txt				US
10.015	Tx1 Destination Address	0.0.0.0 to 255.255.255.255	0.0.0.0	RW	IP				US
10.016	Tx1 Message Rate	0 to 100 ms	0 ms	RW	Num				US

Safety information
Introduction
Mechanical installation
Electrical installation
Getting started
Parameters
Key features and Protocols
PC Applications
Security
Diagnostics
Glossary of terms
Index

Parameter		Range	Default	Type						
10.019	Tx1 Link Status	VLAN disabled (-30), Reserved 29 (-29), Reserved 28 (-28), Reserved 27 (-27), Reserved 26 (-26), Reserved 25 (-25), Reserved 24 (-24), Reserved 23 (-23), Reserved 22 (-22), SYNC unsupported (-21), MEC offset (-20), Invalid tx rate (-19), Too many mapping (-18), Link busy (-17), Invalid profile (-16), Invalid mapping (-15), Read only param (-14), Msg mismatch (-13), Msg too long (-12), Attrib NA (-11), Attrib RO (-10), Attrib missing (-9), Timeout (-8), In error (-7), Link num in use (-6), Not editable (-5), Invalid link num (-4), Invalid args (-3), Too many links (-2), Out of memory (-1), OK (0), Not running (1), OK sync (2)	OK (0)	RO	Txt					
10.020	Tx2 Link Profile	Std (0), Sync (1)	Std (0)	RW	Txt					US
10.021	Tx2 Link Number	0 to 255	0	RW	Num					US
10.022	Tx2 Source Parameter	0.00.000 to 4.99.999	0.00.000	RW	SMP				PT	US
10.023	Tx2 Parameter Count	0 to 10	0	RW	Num					US
10.024	Tx2 Link Transmission Type	Unicast (0), Broadcast (1), Multicast1 (2), Multicast2 (3), Multicast3 (4), Multicast4 (5)	Unicast (0)	RW	Txt					US
10.025	Tx2 Destination Address	0.0.0.0 to 255.255.255.255	0.0.0.0	RW	IP					US
10.026	Tx2 Message Rate	0 to 100 ms	0 ms	RW	Num					US

Parameter		Range	Default	Type					
10.029	Tx2 Link Status	VLAN disabled (-30), Reserved 29 (-29), Reserved 28 (-28), Reserved 27 (-27), Reserved 26 (-26), Reserved 25 (-25), Reserved 24 (-24), Reserved 23 (-23), Reserved 22 (-22), SYNC unsupported (-21), MEC offset (-20), Invalid tx rate (-19), Too many mapping (-18), Link busy (-17), Invalid profile (-16), Invalid mapping (-15), Read only param (-14), Msg mismatch (-13), Msg too long (-12), Attrib NA (-11), Attrib RO (-10), Attrib missing (-9), Timeout (-8), In error (-7), Link num in use (-6), Not editable (-5), Invalid link num (-4), Invalid args (-3), Too many links (-2), Out of memory (-1), OK (0), Not running (1), OK sync (2)	OK (0)	RO	Txt				
10.030	Tx3 Link Profile	Std (0), Sync (1)	Std (0)	RW	Txt			US	
10.031	Tx3 Link Number	0 to 255	0	RW	Num			US	
10.032	Tx3 Source Parameter	0.00.000 to 4.99.999	0.00.000	RW	SMP		PT	US	
10.033	Tx3 Parameter Count	0 to 10	0	RW	Num			US	
10.034	Tx3 Link Transmission Type	Unicast (0), Broadcast (1), Multicast1 (2), Multicast2 (3), Multicast3 (4), Multicast4 (5)	Unicast (0)	RW	Txt			US	
10.035	Tx3 Destination Address	0.0.0.0 to 255.255.255.255	0.0.0.0	RW	IP			US	
10.036	Tx3 Message Rate	0 to 100 ms	0 ms	RW	Num			US	

Safety information
Introduction
Mechanical installation
Electrical installation
Getting started
Parameters
Key features and protocols
PC Applications
Security
Diagnostics
Glossary of terms
Index

Parameter		Range	Default	Type					
10.039	Tx3 Link Status	VLAN disabled (-30), Reserved 29 (-29), Reserved 28 (-28), Reserved 27 (-27), Reserved 26 (-26), Reserved 25 (-25), Reserved 24 (-24), Reserved 23 (-23), Reserved 22 (-22), SYNC unsupported (-21), MEC offset (-20), Invalid tx rate (-19), Too many mapping (-18), Link busy (-17), Invalid profile (-16), Invalid mapping (-15), Read only param (-14), Msg mismatch (-13), Msg too long (-12), Attrib NA (-11), Attrib RO (-10), Attrib missing (-9), Timeout (-8), In error (-7), Link num in use (-6), Not editable (-5), Invalid link num (-4), Invalid args (-3), Too many links (-2), Out of memory (-1), OK (0), Not running (1), OK sync (2)	OK (0)	RO	Txt				
10.040	Rx1 Link Profile	Std (0), Sync (1)	Std (0)	RW	Txt				US
10.041	Rx1 Link Number	0 to 255	0	RW	Num				US
10.042	Rx1 Destination Parameter	0.00.000 to 4.99.999	0.00.000	RW	SMP				US
10.043	Rx1 Parameter Count	0 to 10	0	RW	Num				US
10.044	Rx1 Source Type	Direct (0), Multicast1 (1), Multicast2 (2), Multicast3 (3), Multicast4 (4), Local (5)	Direct (0)	RW	Txt				US
10.045	Rx1 Timeout	0 to 65535 ms	100 ms	RW	Num				US
10.046	Rx1 Timeout Action	Trip (0), Clear output (1), Hold last (2)	Trip (0)	RW	Txt				US
10.047	Rx1 Timeout Event Destination	This slot (0), Slot 1 (1), Slot 2 (2), Slot 3 (3), Slot 4 (4)	This slot (0)	RW	Txt				US

Parameter		Range	Default	Type					
10.048	Rx1 Timeout Event Type	No Event (0), Event (1), Event1 (2), Event2 (3), Event3 (4)	No Event (0)	RW	Txt				US
10.049	Rx1 Link Status	VLAN disabled (-30), Reserved 29 (-29), Reserved 28 (-28), Reserved 27 (-27), Reserved 26 (-26), Reserved 25 (-25), Reserved 24 (-24), Reserved 23 (-23), Reserved 22 (-22), SYNC unsupported (-21), MEC offset (-20), Invalid tx rate (-19), Too many mapping (-18), Link busy (-17), Invalid profile (-16), Invalid mapping (-15), Read only param (-14), Msg mismatch (-13), Msg too long (-12), Attrib NA (-11), Attrib RO (-10), Attrib missing (-9), Timeout (-8), In error (-7), Link num in use (-6), Not editable (-5), Invalid link num (-4), Invalid args (-3), Too many links (-2), Out of memory (-1), OK (0), Not running (1), OK sync (2)	OK (0)	RO	Txt				
10.050	Rx2 Link Profile	Std (0), Sync (1)	Std (0)	RW	Txt				US
10.051	Rx2 Link Number	0 to 255	0	RW	Num				US
10.052	Rx2 Destination Parameter	0.00.000 to 4.99.999	0.00.000	RW	SMP				US
10.053	Rx2 Parameter Count	0 to 10	0	RW	Num				US
10.054	Rx2 Source Type	Direct (0), Multicast1 (1), Multicast2 (2), Multicast3 (3), Multicast4 (4), Local (5)	Direct (0)	RW	Txt				US
10.055	Rx2 Timeout	0 to 65535 ms	100 ms	RW	Num				US
10.056	Rx2 Timeout Action	Trip (0), Clear output (1), Hold last (2)	Trip (0)	RW	Txt				US

Safety information
Introduction
Mechanical installation
Electrical installation
Getting started
Parameters
Key features and protocols
PC Applications
Security
Diagnostics
Glossary of terms
Index

Parameter		Range	Default	Type					
10.057	Rx2 Timeout Event Destination	This slot (0), Slot 1 (1), Slot 2 (2), Slot 3 (3), Slot 4 (4)	This slot (0)	RW	Txt				US
10.058	Rx2 Timeout Event Type	No Event (0), Event (1), Event1 (2), Event2 (3), Event3 (4)	No Event (0)	RW	Txt				US
10.059	Rx2 Link Status	VLAN disabled (-30), Reserved 29 (-29), Reserved 28 (-28), Reserved 27 (-27), Reserved 26 (-26), Reserved 25 (-25), Reserved 24 (-24), Reserved 23 (-23), Reserved 22 (-22), SYNC unsupported (-21), MEC offset (-20), Invalid tx rate (-19), Too many mapping (-18), Link busy (-17), Invalid profile (-16), Invalid mapping (-15), Read only param (-14), Msg mismatch (-13), Msg too long (-12), Attrib NA (-11), Attrib RO (-10), Attrib missing (-9), Timeout (-8), In error (-7), Link num in use (-6), Not editable (-5), Invalid link num (-4), Invalid args (-3), Too many links (-2), Out of memory (-1), OK (0), Not running (1), OK sync (2)	OK (0)	RO	Txt				
10.060	Rx3 Link Profile	Std (0), Sync (1)	Std (0)	RW	Txt				US
10.061	Rx3 Link Number	0 to 255	0	RW	Num				US
10.062	Rx3 Destination Parameter	0.00.000 to 4.99.999	0.00.000	RW	SMP				US
10.063	Rx3 Parameter Count	0 to 10	0	RW	Num				US
10.064	Rx3 Source Type	Direct (0), Multicast1 (1), Multicast2 (2), Multicast3 (3), Multicast4 (4), Local (5)	Direct (0)	RW	Txt				US
10.065	Rx3 Timeout	0 to 65535 ms	100 ms	RW	Num				US

Parameter		Range	Default	Type					
10.066	Rx3 Timeout Action	Trip (0), Clear output (1), Hold last (2)	Trip (0)	RW	Txt				US
10.067	Rx3 Timeout Event Destination	This slot (0), Slot 1 (1), Slot 2 (2), Slot 3 (3), Slot 4 (4)	This slot (0)	RW	Txt				US
10.068	Rx3 Timeout Event Type	No Event (0), Event (1), Event1 (2), Event2 (3), Event3 (4)	No Event (0)	RW	Txt				US
10.069	Rx3 Link Status	VLAN disabled (-30), Reserved 29 (-29), Reserved 28 (-28), Reserved 27 (-27), Reserved 26 (-26), Reserved 25 (-25), Reserved 24 (-24), Reserved 23 (-23), Reserved 22 (-22), SYNC unsupported (-21), MEC offset (-20), Invalid tx rate (-19), Too many mapping (-18), Link busy (-17), Invalid profile (-16), Invalid mapping (-15), Read only param (-14), Msg mismatch (-13), Msg too long (-12), Attrib NA (-11), Attrib RO (-10), Attrib missing (-9), Timeout (-8), In error (-7), Link num in use (-6), Not editable (-5), Invalid link num (-4), Invalid args (-3), Too many links (-2), Out of memory (-1), OK (0), Not running (1), OK sync (2)	OK (0)	RO	Txt				

Safety information
Introduction
Mechanical installation
Electrical installation
Getting started
Parameters
Key features and Protocols
PC Applications
Security
Diagnostics
Glossary of terms
Index

5.10.5 Menu 11 - Synchronization

Table 5.9 Menu 11 parameters

Parameter		Range	Default	Type					
11.001	Preferred Sync Master	0 to 4	1	RW	Num				US
11.002	Master Clock Domain	0 to 3	0	RW	Num				US
11.005	Grandmaster MAC Address	00:00:00:00:00:00 to FF:FF:FF:FF:FF:FF		RO	Mac	ND	NC	PT	
11.006	Synchronization Jitter From Grandmaster	-2147483648 to 2147483647 ns		RO	Num	ND	NC	PT	
11.007	Synchronization Jitter Threshold	500 to 1000000 ns	1000 ns	RW	Num				US
11.008	Module Synchronized Flag	Off (0) or On (1)	Off (0)	RO	Bit				
11.009	Inhibit Drive Synchronization	Off (0) or On (1)	Off (0)	RW	Bit				US
11.010	PTP Date	00-00-00 to 31-12-99		RO	Date	ND	NC	PT	
11.011	PTP Time	00:00:00 to 23:59:59		RO	Time	ND	NC	PT	
11.016	PTP Sync Rate	-4 to 0	-4	RW	Num				US
11.017	In sync window length	3 to 255 s	20 s	RW	Num				US
11.020	Network Error Count	0 to 4294967295		RO	Num	ND	NC	PT	
11.022	Interoption Sync Status	MASTER (0), PRODUCER (1), INDEPENDENT (2)		RO	Txt	ND	NC	PT	
11.030	Easy Mode Maximum Network Delay	1 to 100 ms	3 ms	RW	Num				US
11.040	Rx1 Late Synchronization Frame Action	Trip (1), Do not use (2), Use (3)	Trip (1)	RW	Txt				US
11.041	Rx1 Late Synchronization Frame Destination	This slot (0), Slot 1 (1), Slot 2 (2), Slot 3 (3), Slot 4 (4)	This slot (0)	RW	Txt				US
11.042	Rx1 Late Synchronization Frame Event	No Event (0), Event 1 (1), Event 2 (2), Event 3 (3), Event 4 (4)	No Event (0)	RW	Txt				US
11.050	Rx2 Late Synchronization Frame Action	Trip (1), Do not use (2), Use (3)	Trip (1)	RW	Txt				US
11.051	Rx2 Late Synchronization Frame Destination	This slot (0), Slot 1 (1), Slot 2 (2), Slot 3 (3), Slot 4 (4)	This slot (0)	RW	Txt				US

Parameter		Range	Default	Type					
11.052	Rx2 Late Synchronization Frame Event	No Event (0), Event (1), Event 1 (2), Event 2 (3), Event 3 (4)	No Event (0)	RW	Txt				US
11.060	Rx3 Late Synchronization Frame Action	Trip (1), Do not use (2), Use (3)	Trip (1)	RW	Txt				US
11.061	Rx3 Late Synchronization Frame Destination	This slot (0), Slot 1 (1), Slot 2 (2), Slot 3 (3), Slot 4 (4)	This slot (0)	RW	Txt				US
11.062	Rx3 Late Synchronization Frame Event	No Event (0), Event (1), Event 1 (2), Event 2 (3), Event 3 (4)	No Event (0)	RW	Txt				US

5.10.6 Menu 15 - Modbus

Table 5.10 Menu 15 parameters

Parameter		Range	Default	Type					
15.001	Enable	Off (0) or On (1)	On (1)	RW	Bit				US
15.002	Reset	Off (0) or On (1)	Off (0)	RW	Bit		NC		
15.003	Default	Off (0) or On (1)	Off (0)	RW	Bit		NC		
15.004	Modbus Configuration Error	No error (0), Port in use (1), Timeout event (2), Num Connections (3)		RO	Txt	ND			
15.005	Modbus Listening Port	0 to 65535	502	RW	Num				US
15.006	Maximum Connections	0 to 4	2	RW	Num				US
15.007	Maximum Priority Connections	0 to 4	0	RW	Num				US
15.008	Maximum Connections Per Client	1 to 4	2	RW	Num				US
15.009	Modbus Timeout	1 to 10000 ms	100 ms	RW	Num				US
15.010	Modbus Timeout Action	Trip (0), No action (1)	No action (1)	RW	Txt				US

Safety information
Introduction
Mechanical installation
Electrical installation
Getting started
Parameters
Key features and Protocols
PC Applications
Security
Diagnostics
Glossary of terms
Index

Parameter		Range	Default	Type						
15.011	Modbus Timeout Event Destination	This slot (0), Slot 1 (1), Slot 2 (2), Slot 3 (3), Slot 4 (4)	This slot (0)	RW	Txt					US
15.012	Modbus Timeout Event Type	No event (0), Trigger Event (1), Trigger Event 1 (2), Trigger Event 2 (3), Trigger Event 3 (4), Trigger Event 4 (5)	No event (0)	RW	Txt					US
15.013	Modbus Register Addressing Mode	Standard (0), Modified (1)	Standard (0)	RW	Txt					US
15.020	Priority Connection 1	0.0.0.0 to 255.255.255.255	0.0.0.0	RW	IP					US
15.021	Priority Connection 2	0.0.0.0 to 255.255.255.255	0.0.0.0	RW	IP					US
15.022	Priority Connection 3	0.0.0.0 to 255.255.255.255	0.0.0.0	RW	IP					US
15.023	Priority Connection 4	0.0.0.0 to 255.255.255.255	0.0.0.0	RW	IP					US

5.10.7 Menu 20 - EtherNet/IP Setup

Table 5.11 Menu 20 parameters

Parameter		Range	Default	Type						
20.001	Enable EtherNet/IP	Off (0) or On (1)	On (1)	RW	Bit					US
20.002	Reset	Off (0) or On (1)	Off (0)	RW	Bit		NC			
20.003	Default	Off (0) or On (1)	Off (0)	RW	Bit		NC			
20.004	Configuration error	No error (0), RPI event dst (1), RPI event type (2), IDLE event dst (3), IDLE event type (4), Input mapping (5), Output mapping (6), In cons trig pr (7), Out cons trig pr (8)		RO	Txt	ND	NC	PT		
20.007	Cyclic data transfers per second	0 to 65535 Messages/s		RO	Num	ND	NC	PT		
20.011	RPI timeout action	Trip (0), Send fit values (1), Clear output (2), Hold last (3), No Action (4)	Hold last (3)	RW	Txt					US
20.012	RPI timeout event destination	This slot (0), Slot 1 (1), Slot 2 (2), Slot 3 (3), Slot 4 (4)	This slot (0)	RW	Txt					US

Parameter		Range	Default	Type						
20.013	RPI timeout event type	No event (0), Trigger Event (1), Trigger Event 1 (2), Trigger Event 2 (3), Trigger Event 3 (4), Trigger Event 4 (5)	No event (0)	RW	Txt					US
20.015	PLC idle action	Trip (0), Send fit values (1), Clear output (2), Hold last (3), No action (4)	No action (4)	RW	Txt					US
20.016	PLC idle action destination	This slot (0), Slot 1 (1), Slot 2 (2), Slot 3 (3), Slot 4 (4)	This slot (0)	RW	Txt					US
20.017	PLC idle action type	No event (0), Trigger Event (1), Trigger Event 1 (2), Trigger Event 2 (3), Trigger Event 3 (4), Trigger Event 4 (5)	No event (0)	RW	Txt					US
20.018	Active input assembly object	100-PrimaryI (0), 70-BscSpdCtrlI (1), 71-ExtSpdCtrlI (2), 72-SpdTqCtrlI (3), 73-ExtSpdTqCtrlI (4)	100-PrimaryI (0)	RO	Txt		NC	PT		
20.019	Active output assembly object	101-PrimaryO (0), 20-BscSpdCtrlO (1), 21-ExtSpdCtrlO (2), 22-SpdTqCtrlO (3), 23-ExtSpdTqCtrlO (4)	101-PrimaryO (0)	RO	Txt		NC	PT		
20.020	Input assembly object size	40 to 80 Bytes	8 Bytes	RW	Num					US
20.021	Output assembly object size	40 to 80 Bytes	8 Bytes	RW	Num					US
20.024	Input assembly object process time	0 to 65535 ms		RO	Num	ND	NC	PT		
20.025	Output assembly object process time	0 to 65535 ms		RO	Num	ND	NC	PT		
20.026	Input assembly object consistency enable	Off (0) or On (1)	Off (0)	RW	Bit					US
20.027	Input assembly object consistency trigger parameter	0.00.000 to 4.99.999	0.00.000	RW	SMP					US
20.028	Output assembly object consistency enable	Off (0) or On (1)	Off (0)	RW	Bit					US
20.029	Output assembly object consistency trigger parameter	0.00.000 to 4.99.999	0.00.000	RW	SMP					US
20.030	Custom Vendor ID	257 - CT (0), 553 - CT AMERICA (1)	257 - CT (0)	RW	Txt					US
20.031	Custom product code	0 to 65535	0	RW	Num					US

Safety information
Introduction
Mechanical installation
Electrical installation
Getting started
Parameters
Key features and protocols
PC Applications
Security
Diagnostics
Glossary of terms
Index

Parameter		Range	Default	Type					
20.032	Custom product revision code	0 to 65535	0	RW	Num				US
20.033	Actual product code	0 to 65535	0	RO	Num		NC	PT	
20.034	Actual product revision	0 to 65535	0	RO	Num		NC	PT	
20.040	Type of Motor 1	2-FC DC (0), 6-WRI (1), 7-SCI (2), 9-Sin PM BL (3), 10-Trap PM BL (4)	7-SCI (2)	RO	Txt			PT	US
20.041	Type of Motor 2	2-FC DC (0), 6-WRI (1), 7-SCI (2), 9-Sin PM BL (3), 10-Trap PM BL (4)	7-SCI (2)	RO	Txt			PT	US

5.10.8 Menu 21 - EtherNet/IP In Mappings

Table 5.12 Menu 21 parameters

Parameter		Range	Default	Type					
21.001	Input mapping parameter 1	0.00.000 to 4.99.999	0.10.040	RW	SMP	DE		PT	US
21.002	Input mapping parameter 2	0.00.000 to 4.99.999	0.02.001	RW	SMP	DE		PT	US
21.003	Input mapping parameter 3	0.00.000 to 4.99.999	0.00.000	RW	SMP	DE		PT	US
21.004	Input mapping parameter 4	0.00.000 to 4.99.999	0.00.000	RW	SMP	DE		PT	US
21.005	Input mapping parameter 5	0.00.000 to 4.99.999	0.00.000	RW	SMP	DE		PT	US
21.006	Input mapping parameter 6	0.00.000 to 4.99.999	0.00.000	RW	SMP	DE		PT	US
21.007	Input mapping parameter 7	0.00.000 to 4.99.999	0.00.000	RW	SMP	DE		PT	US
21.008	Input mapping parameter 8	0.00.000 to 4.99.999	0.00.000	RW	SMP	DE		PT	US
21.009	Input mapping parameter 9	0.00.000 to 4.99.999	0.00.000	RW	SMP	DE		PT	US
21.010	Input mapping parameter 10	0.00.000 to 4.99.999	0.00.000	RW	SMP	DE		PT	US
21.011	Input mapping parameter 11	0.00.000 to 4.99.999	0.00.000	RW	SMP	DE		PT	US
21.012	Input mapping parameter 12	0.00.000 to 4.99.999	0.00.000	RW	SMP	DE		PT	US
21.013	Input mapping parameter 13	0.00.000 to 4.99.999	0.00.000	RW	SMP	DE		PT	US
21.014	Input mapping parameter 14	0.00.000 to 4.99.999	0.00.000	RW	SMP	DE		PT	US
21.015	Input mapping parameter 15	0.00.000 to 4.99.999	0.00.000	RW	SMP	DE		PT	US
21.016	Input mapping parameter 16	0.00.000 to 4.99.999	0.00.000	RW	SMP	DE		PT	US
21.017	Input mapping parameter 17	0.00.000 to 4.99.999	0.00.000	RW	SMP	DE		PT	US
21.018	Input mapping parameter 18	0.00.000 to 4.99.999	0.00.000	RW	SMP	DE		PT	US
21.019	Input mapping parameter 19	0.00.000 to 4.99.999	0.00.000	RW	SMP	DE		PT	US
21.020	Input mapping parameter 20	0.00.000 to 4.99.999	0.00.000	RW	SMP	DE		PT	US

Safety information
Introduction
Mechanical installation
Electrical installation
Getting started
Parameters
Key features and Protocols
PC Applications
Security
Diagnostics
Glossary of terms
Index

5.10.9 Menu 22 - EtherNet/IP Out Mappings

Table 5.13 Menu 22 parameters

Parameter		Range	Default	Type					
22.001	Output mapping parameter 1	0.00.000 to 4.99.999	0.06.042	RW	SMP	DE		PT	US
22.002	Output mapping parameter 2	0.00.000 to 4.99.999	0.01.021	RW	SMP	DE		PT	US
22.003	Output mapping parameter 3	0.00.000 to 4.99.999	0.00.000	RW	SMP	DE		PT	US
22.004	Output mapping parameter 4	0.00.000 to 4.99.999	0.0.0.000	RW	SMP	DE		PT	US
22.005	Output mapping parameter 5	0.00.000 to 4.99.999	0.00.000	RW	SMP	DE		PT	US
22.006	Output mapping parameter 6	0.00.000 to 4.99.999	0.00.000	RW	SMP	DE		PT	US
22.007	Output mapping parameter 7	0.00.000 to 4.99.999	0.00.000	RW	SMP	DE		PT	US
22.008	Output mapping parameter 8	0.00.000 to 4.99.999	0.00.000	RW	SMP	DE		PT	US
22.009	Output mapping parameter 9	0.00.000 to 4.99.999	0.00.000	RW	SMP	DE		PT	US
22.010	Output mapping parameter 10	0.00.000 to 4.99.999	0.00.000	RW	SMP	DE		PT	US
22.011	Output mapping parameter 11	0.00.000 to 4.99.999	0.00.000	RW	SMP	DE		PT	US
22.012	Output mapping parameter 12	0.00.000 to 4.99.999	0.00.000	RW	SMP	DE		PT	US
22.013	Output mapping parameter 13	0.00.000 to 4.99.999	0.00.000	RW	SMP	DE		PT	US
22.014	Output mapping parameter 14	0.00.000 to 4.99.999	0.00.000	RW	SMP	DE		PT	US
22.015	Output mapping parameter 15	0.00.000 to 4.99.999	0.00.000	RW	SMP	DE		PT	US
22.016	Output mapping parameter 16	0.00.000 to 4.99.999	0.00.000	RW	SMP	DE		PT	US
22.017	Output mapping parameter 17	0.00.000 to 4.99.999	0.00.000	RW	SMP	DE		PT	US
22.018	Output mapping parameter 18	0.00.000 to 4.99.999	0.00.000	RW	SMP	DE		PT	US
22.019	Output mapping parameter 19	0.00.000 to 4.99.999	0.00.000	RW	SMP	DE		PT	US
22.020	Output mapping parameter 20	0.00.000 to 4.99.999	0.00.000	RW	SMP	DE		PT	US

5.10.10 Menu 23 - EtherNet/IP Fault Values

Table 5.14 Menu 23 parameters

Parameter		Range	Default	Type					
23.001	Output fault value 1	-2147483648 to 2147483647	0	RW	Num			PT	US
23.002	Output fault value 2	-2147483648 to 2147483647	0	RW	Num			PT	US
23.003	Output fault value 3	-2147483648 to 2147483647	0	RW	Num			PT	US
23.004	Output fault value 4	-2147483648 to 2147483647	0	RW	Num			PT	US
23.005	Output fault value 5	-2147483648 to 2147483647	0	RW	Num			PT	US
23.006	Output fault value 6	-2147483648 to 2147483647	0	RW	Num			PT	US
23.007	Output fault value 7	-2147483648 to 2147483647	0	RW	Num			PT	US
23.008	Output fault value 8	-2147483648 to 2147483647	0	RW	Num			PT	US
23.009	Output fault value 9	-2147483648 to 2147483647	0	RW	Num			PT	US
23.010	Output fault value 10	-2147483648 to 2147483647	0	RW	Num			PT	US
23.011	Output fault value 11	-2147483648 to 2147483647	0	RW	Num			PT	US
23.012	Output fault value 12	-2147483648 to 2147483647	0	RW	Num			PT	US
23.013	Output fault value 13	-2147483648 to 2147483647	0	RW	Num			PT	US
23.014	Output fault value 14	-2147483648 to 2147483647	0	RW	Num			PT	US
23.015	Output fault value 15	-2147483648 to 2147483647	0	RW	Num			PT	US
23.016	Output fault value 16	-2147483648 to 2147483647	0	RW	Num			PT	US
23.017	Output fault value 17	-2147483648 to 2147483647	0	RW	Num			PT	US
23.018	Output fault value 18	-2147483648 to 2147483647	0	RW	Num			PT	US
23.019	Output fault value 19	-2147483648 to 2147483647	0	RW	Num			PT	US
23.020	Output fault value 20	-2147483648 to 2147483647	0	RW	Num			PT	US

Safety information
Introduction
Mechanical installation
Electrical installation
Getting started
Parameters
Key features and protocols
PC Applications
Security
Diagnostics
Glossary of terms
Index

6 Parameters

The Ethernet interface holds two parameter databases; the Ethernet interface internal parameter database and the host drive's parameter database.

The Ethernet interface internal parameters can be accessed from the drive's keypad, a user program in a MCI200/MCI210 option module, PC Tools applications software or a module in another slot of the drive. The notation **S.mm.ppp** is used to access these parameters where **S** is the slot number, **mm** is the menu number and **ppp** is the parameter number. For example, to access Pr **03.010** of a MCI210 installed in slot 2 of a drive from a module in slot 3, it will be accessed using Pr **2.03.010**.

The Ethernet interface will also hold a copy of the host drive's database. At power up, if the stored drive database is different to that of the drive, the Ethernet interface will upload the drive's database and overwrite the stored database. If the two databases match, the drive's database will not be uploaded.

A module that is powered up for the first time will not contain a drive database and therefore will perform a drive database upload.

6.1 Menus

Table 6.1 Ethernet internal menus

Menu	Description
S.0	Ethernet setup (MM.ppp)
S.2	Ethernet configuration
S.9	Resources
S.10	Easy mode cyclic data
S.11	Synchronization
S.15	Modbus
S.20	EtherNet/IP setup
S.21	EtherNet/IP in mappings
S.22	EtherNet/IP out mappings
S.23	EtherNet/IP fault values

S is the slot number where the module is installed.

Menu 0 within the Ethernet interface, is also displayed in the drive menu 15, 16, 17 or 24 depending on which slot the Ethernet interface is installed to and the setting of *Option Slot Identifiers* (**11.056**).

By default, the SI-Ethernet option module will be either menu 15, 16 or 17 and the onboard Ethernet interface will be menu 24.

6.1.1 Menu 0 - Ethernet setup

S.00.001	Module ID		
Minimum	0	Maximum	65535
Default		Units	
Type	16 Bit Volatile	Update Rate	Power-up write
Display Format	None	Decimal Places	0
Coding	RO, ND, NC, PT, BU		

The Module ID:

- Onboard Ethernet = 430
- SI-Ethernet option module = 433

S.00.002	Software version		
Minimum	0 (Display 00.00.00.00)	Maximum	99999999 (Display 99.99.99.99)
Default		Units	
Type	32 Bit Volatile	Update Rate	
Display Format	Version Number	Decimal Places	0
Coding	RO, ND, NC, PT		

Module firmware version in **ww.xx.yy.zz** format.

S.00.003	Hardware version		
Minimum	00.00	Maximum	99.99
Default		Units	
Type	16 Bit Volatile	Update Rate	
Display Format	None	Decimal Places	2
Coding	RO, ND, NC, PT		

The hardware version of the option module is in the format of **xx.yy**.

S.00.004	Serial Number LS		
Minimum	0	Maximum	99999999
Default		Units	
Type	32 Bit Volatile	Update Rate	Power-up write
Display Format	Lead Zero Pad	Decimal Places	0
Coding	RO, ND, NC, PT		

The module serial number is available as a pair of 32-bit values where *Serial Number LS* (**S.00.004**) provides the least significant 8 decimal digits, and *Serial Number MS* (**S.00.005**) provides the most significant 8 decimal digits. The reconstructed serial number is $((\mathbf{S.00.005} \times 100000000) + \mathbf{S.00.004})$. For example serial number "0001234567898765" would be stored as **S.00.005** = 12345 and **S.00.004** = 67898765.

S.00.005		Serial Number MS	
Minimum	0	Maximum	99999999
Default		Units	
Type	32 Bit Volatile	Update Rate	Power-up write
Display Format	None	Decimal Places	0
Coding	RO, ND, NC, PT		

See *Serial Number LS (S.00.004)*

S.00.006		Status	
Minimum	-2	Maximum	3
Default		Units	
Type	8 Bit Volatile	Update Rate	Background
Display Format	None	Decimal Places	0
Coding	RO, TE, ND, NC, PT		

This parameter displays the current status of the module. All possible values are shown in the table below.

Value	Text	Description
-2	Bootldr-Update	The bootloader is performing a flash update.
-1	Bootldr-Idle	The bootloader is idle.
0	Initialising	Module is currently initializing.
1	OK	Module has initialized and has found no errors.
2	Config	A configuration error has been detected.
3	Error	An error has occurred preventing the module from running correctly.

S.00.007		Reset	
Minimum	0	Maximum	1
Default	0	Units	
Type	1 Bit Volatile	Update Rate	Read every 200 ms, Written to 0 on module initialization.
Display Format	None	Decimal Places	0
Coding	RW, NC		

When set, the module performs a warm reset. When the reset has been performed and the module is performing its initialization routines the parameter will be cleared to zero.

NOTE The drive, and any other modules fitted to the drive, will not be affected by the reset.

S.00.008	Default		
Minimum	0	Maximum	1
Default	0	Units	
Type	1 Bit Volatile	Update Rate	Read every 200 ms, Written to 0 on module initialization.
Display Format	None	Decimal Places	0
Coding	RW, NC		

If set to "ON" when the module is reset, this parameter will cause the option module to return to it's "Out of box configuration" and any settings stored on the module will be returned to their default values. This will include any Web page customisations, e-mail settings, etc. Following the default the module will set the parameter to "OFF" and the module will reset.

Take care using this parameter as any configuration information will be irretrievably lost!

S.00.009	Active Alarm Bits		
Minimum	0 (Display:0000000000000000)	Maximum	65535 (Display:1111111111111111)
Default	0 (Display:0000000000000000)	Units	
Type	16 Bit Volatile	Update Rate	Background
Display Format	Binary	Decimal Places	0
Coding	RO, NC, BU		

Bit	Alarm
0	User Program
1	eCMP
2	Modbus
3	Ethernet/IP
4	Reserved
5	Filesystem
6	Too Hot

Safety information
Introduction
Mechanical installation
Electrical installation
Getting started
Parameters
Key features and Protocols
PC Applications
Security
Diagnostics
Glossary of terms
Index

S.00.010		Active IP Address	
Minimum	-2147483648 (Display:128.0.0.0)	Maximum	2147483647 (Display:127.255.255.255)
Default	0 (Display: 0.0.0.0)	Units	
Type	32 Bit Volatile	Update Rate	Background
Display Format	IP Address	Decimal Places	0
Coding	RO, NC, PT		

The module's active IP address.

6.1.2 Menu 2 - Ethernet configuration

S.02.003		Network Status	
Minimum	0	Maximum	5
Default		Units	
Type	8 Bit Volatile	Update Rate	Written every second
Display Format	None	Decimal Places	0
Coding	RO, TE, ND, NC, PT, BU		

Value	Text	Description
0	Initialising	The network interface is being initialized
1	Links Down	No link connection has been detected on either of the Ethernet ports
2	DHCP In Progress	The module is attempting to obtain the IP address, subnet mask, default gateway and DNS server addresses from a DHCP server
3	No Address	The module does not have an IP address - either the user has not provided one manually or one could not be allocated via DHCP
4	Ready	The network interface has been successfully configured but no data is being received or transmitted
5	Active	The network interface is receiving or transmitting data

This parameter indicates the status of the network that the module is connected to.

S.02.004		Network Message Count	
Minimum	0	Maximum	65535
Default		Units	Messages/s
Type	16 Bit Volatile	Update Rate	Written every second
Display Format	None	Decimal Places	0
Coding	RO, ND, NC, PT, BU		

This parameter displays the number of frames that the module is transmitting and/or receiving every second.

S.02.005		DHCP Enable	
Minimum	0	Maximum	1
Default	1	Units	
Type	1 Bit User Save	Update Rate	Background read
Display Format	None	Decimal Places	0
Coding	RW, BU		

Controls whether or not the module will attempt to use a Dynamic Host Configuration Protocol (DHCP) server to obtain the IP address, subnet mask, default gateway and DNS servers.

When DHCP is enabled, the following parameters will become read-only immediately (no reset required):

- IP Address (**S.02.006**)
- Subnet Mask (**S.02.007**)
- Default Gateway (**S.02.008**)
- Primary DNS (**S.02.009**)
- Secondary DNS (**S.02.010**)

S.02.006		IP Address	
Minimum	0 (Display: 0.0.0.0)	Maximum	4294967295 (Display:255.255.255.255)
Default	3232235876 (Display:192.168.1.100)	Units	
Type	32 Bit User Save	Update Rate	DHCP enabled: write on event; DHCP disabled: read on reset
Display Format	IP Address	Decimal Places	0
Coding	RW, BU		

Controls and displays the IP address of the module.

If DHCP is enabled this parameter becomes read-only, and until an IP address is allocated to the module will display 0.0.0.0.

If DHCP is disabled the module will initialize, on reset or power cycle, with the IP address stored for the parameter.

Safety information
Introduction
Mechanical installation
Electrical installation
Getting started
Parameters
Key features and Protocols
PC Applications
Security
Diagnostics
Glossary of terms
Index

S.02.007		Subnet Mask	
Minimum	0 (Display: 0.0.0.0)	Maximum	4294967295 (Display:255.255.255.255)
Default	4294967040 (Display:255.255.255.0)	Units	
Type	32 Bit User Save	Update Rate	DHCP enabled: write on event; DHCP disabled: read on reset
Display Format	IP Address	Decimal Places	0
Coding	RW, BU		

Controls and displays the subnet mask of the module.

If DHCP is enabled this parameter becomes read-only, and until a subnet mask is allocated to the module will display 0.0.0.0.

If DHCP is disabled the module will initialize, on reset or power cycle, with the subnet mask stored for the parameter.

S.02.008		Default Gateway	
Minimum	0 (Display: 0.0.0.0)	Maximum	4294967295 (Display:255.255.255.255)
Default	3232236030 (Display:192.168.1.254)	Units	
Type	32 Bit User Save	Update Rate	DHCP enabled: write on event; DHCP disabled: read on reset
Display Format	IP Address	Decimal Places	0
Coding	RW, BU		

Controls and displays the default gateway of the module.

If DHCP is enabled this parameter becomes read-only, and until a default gateway is allocated to the module will display 0.0.0.0.

If DHCP is disabled the module will initialize, on reset or power cycle, with the default gateway stored for the parameter.

S.02.009		Primary DNS	
Minimum	0 (Display: 0.0.0.0)	Maximum	4294967295 (Display:255.255.255.255)
Default	0 (Display: 0.0.0.0)	Units	
Type	32 Bit User Save	Update Rate	DHCP enabled: write on event; DHCP disabled: read on reset
Display Format	IP Address	Decimal Places	0
Coding	RW, BU		

The module can use this IP address when it wishes to resolve the IP address for a domain name. This parameter performs the same function as *Secondary DNS* (**S.02.010**), however the address specified in this parameter will be tried first. Only when this address is unsuccessful will the secondary DNS address be tried.

If DHCP is enabled this parameter becomes read-only, and until a primary DNS address is allocated to the module will display 0.0.0.0.

If DHCP is disabled the module will initialize, on reset or power cycle, with the primary DNS address stored for the parameter.

S.02.010		Secondary DNS	
Minimum	0 (Display: 0.0.0.0)	Maximum	4294967295 (Display:255.255.255.255)
Default	0 (Display: 0.0.0.0)	Units	
Type	32 Bit User Save	Update Rate	DHCP enabled: write on event; DHCP disabled: read on reset
Display Format	IP Address	Decimal Places	0
Coding	RW, BU		

The module can use this IP address when it wishes to resolve the IP address for a domain name. This parameter performs the same function as *Primary DNS* (**S.02.009**), however the address specified in this parameter will be tried only when the primary DNS address is unsuccessful.

If DHCP is enabled this parameter becomes read-only, and until a secondary DNS address is allocated to the module will display 0.0.0.0.

If DHCP is disabled the module will initialize, on reset or power cycle, with the secondary DNS address stored for the parameter.

Safety information
Introduction
Mechanical installation
Electrical installation
Getting started
Parameters
Key features and Protocols
PC Applications
Security
Diagnostics
Glossary of terms
Index

S.02.011		MAC Address	
Minimum	0 (Display:00.00.00.00.00.00)	Maximum	281474976710655 (Display:FF:FF:FF:FF:FF:FF)
Default		Units	
Type	64 bit volatile	Update Rate	Power-up write
Display Format	MAC Address	Decimal Places	0
Coding	RO, ND, NC, PT, BU		

The 48-bit MAC address of the module.

S.02.020		Priority Protocol	
Minimum	0	Maximum	2
Default	0	Units	
Type	8 Bit User Save	Update Rate	Background read
Display Format	None	Decimal Places	0
Coding	RW, TE, BU		

Selection of the fieldbus protocol to have priority over all other protocols.

Value	Text	Description
0	None	All protocols have equal priority
1	Modbus TCP	Modbus TCP has highest priority
2	EtherNet/IP	EtherNet/IP has highest priority

Enables selection of one fieldbus protocol to have priority over others. A tick period of 1 ms will be given to the highest priority fieldbus protocol, 5 ms to all other fieldbus protocols (equal priority).

If no fieldbus protocol has been selected to have priority over others, all protocols will have equal priority and a tick rate of 5 ms.

S.02.021		Web Server Enable	
Minimum	0	Maximum	1
Default	1	Units	
Type	1 Bit User Save	Update Rate	Background read
Display Format	None	Decimal Places	0
Coding	RW, BU		

Controls the running of the web server on the module.

NOTE The web server functionality is not currently implemented.

S.02.022		Web Server Port	
Minimum	0	Maximum	65535
Default	80	Units	
Type	1 Bit User Save	Update Rate	Read on module reset and HTTP_ENABLE
Display Format	None	Decimal Places	0
Coding	RW, BU		

The web server port. This may be changed for added security.

NOTE The web server functionality is not currently implemented.

S.02.024		Ethernet MTU	
Minimum	158	Maximum	1500
Default	1500	Units	Bytes
Type	16 Bit User Save	Update Rate	Read on module reset
Display Format	None	Decimal Places	0
Coding	RW, BU		

Specifies the MTU (Maximum Transmittable Unit) in bytes allowed by the Ethernet interface.

S.02.025		Gateway Mode	
Minimum	0	Maximum	2
Default	0	Units	
Type	8 Bit User Save	Update Rate	Read on module reset
Display Format	None	Decimal Places	0
Coding	RW, TE, BU		

Value	Text
0	Switch
1	Gateway
2	Strict Gateway

Specifies the operation mode of the gateway. By default the gateway is disabled and the switch operates in normal switch mode. By enabling the gateway mode all packets are filtered by the module and prioritized before being forwarded on. In strict mode the gateway will drop packets from unsupported protocols.

Safety information
Introduction
Mechanical installation
Electrical installation
Getting started
Parameters
Key features and Protocols
PC Applications
Security
Diagnostics
Glossary of terms
Index

S.02.030		VLAN Enable	
Minimum	0	Maximum	1
Default	0	Units	
Type	1 Bit User Save	Update Rate	Read on module reset
Display Format	None	Decimal Places	0
Coding	RW		

Controls whether the module will use VLAN tagging.

When used in conjunction with *Drive VLAN ID (S.02.031)* network traffic from the interface will be tagged with the chosen VLAN identifier.

When default value for *Drive VLAN ID (S.02.031)* is set, enabling this parameter will add VLAN prioritisation to all packets, helping to ensure real-time packets are not delayed by those of lower priority. If disabled, prioritization will use the Diffserv field in IP traffic only, meaning non-IP traffic can still affect real-time IP traffic.

S.02.031		Drive VLAN ID	
Minimum	0	Maximum	255
Default	0	Units	
Type	8 Bit User Save	Update Rate	Read on module reset and VLAN_ENABLE
Display Format	None	Decimal Places	0
Coding	RW, BU		

Specifies the VLAN ID that the interface will be a member of. Any packets entering the switch without this VLAN ID will not be handled.

S.02.035		Non cyclic enable	
Minimum	0	Maximum	1
Default	0	Units	
Type	1 Bit User Save	Update Rate	Background
Display Format	None	Decimal Places	0
Coding	RW		

Enable the Non cyclic data transfer.

S.02.036		Non cyclic base parameter	
Minimum	0 (Display: 0.00.000)	Maximum	59999 (Display: 0.59.999)
Default	0 (Display: 0.00.000)	Units	
Type	16 Bit User Save	Update Rate	Background
Display Format	Slot Menu Param	Decimal Places	0
Coding	RW, BU		

The value in this parameter points to the base address of a group of seven sequential parameters which are used for handling non cyclic data by user programs.

The following table illustrates the function of each of these parameters with the base parameter (**MM.PPP**) identified as **S.MM.PPP**.

Parameter	Description
S.MM.PPP	Base parameter - status (bits b15 to b8) and command (bits b7 to b0) information
S.MM.PPP + 1	2 nd parameter in sequence - Destination IP address (wwwxxx)
S.MM.PPP + 2	3 rd parameter in sequence - Destination IP address (yyzzzz)
S.MM.PPP + 3	4 th parameter in sequence - target / source parameter address (SMM)
S.MM.PPP + 4	5 th parameter in sequence - target / source parameter address (PPP)
S.MM.PPP + 5	6 th parameter in sequence - target / source parameter value (LSW) or error code
S.MM.PPP + 6	7 th parameter in sequence - target / source parameter value (MSW)

NOTE Each parameter must be at least 16 bits in size.

S.MM.PPP : Status and Command

This parameter contains the command code (bits b7 to b0) and status (bits b15 to b8) information.

Possible values for Status are:

Value	Meaning	Description
0	IDLE	Idle.
1	READY	The parameter channel is ready to take command.
2	PROCESSING	Processing the command.
3	OK	The command processed successfully.
4	ERROR	Error is detected, detail will be found in the first parameter.

Possible values for Command (bits b7 to b0) are:

Value	Meaning	Description
0	No Command	No command or Abort during a command process.
1	Check / Abort	Check if the status idle or abort from read or write command.
2	Read	Read one parameter.
3	Write	Write one parameter.

S.MM.PPP + 1 : Destination IP address (wwwxxx)

This parameter is used to specify the first two octets (wwwxxx) of the destination IP address.

S.MM.PPP + 2 : Destination IP address (yyzzzz)

This parameter is used to specify the last two octets (yyzzzz) of the destination IP address.

NOTE The value 127.0.0.1 would access the current drive.

Safety information
Introduction
Mechanical installation
Electrical installation
Getting started
Parameters
Key features and Protocols
PC Applications
Security
Diagnostics
Glossary of terms
Index

S.MM.PPP + 3 : Target / source parameter address (SMM)

This parameter specifies the slot number (S) and menu number (MM) of the target or source parameter.

S.MM.PPP + 4 : Target / source parameter address (PPP)

This parameter specifies the parameter number (PPP) of the target or source parameter.

S.MM.PPP + 5 : Parameter value (LSW) or error code

This parameter:

- Stores the least significant word of the value to be written to the destination parameter if the command is Write (2) or
- Stores the least significant word of the value read from the destination parameter if the command is read and the status is Done or
- The error code for the process if the status is Error

The following table list the possible error codes:

Value	Meaning	Description
-1	Address Type	The addressing type is not supported.
-2	Timeout	A timeout occurred trying to access the specified item.
-3	Access Denied	The requesting device does not have sufficient access rights.
-4	Does not exist	The specified item does not exist.
-5	Data Type	The data could not be converted from the specified type.
-6	Failed Read	The value could not be read, reason unknown.
-7	Failed Write	The value could not be written, reason unknown.
-8	Not Readable	The data could not be read as the source does not allow read access.
-9	Not Writeable	The data could not be written as the destination does not allow write access.
-10	Over Range	The specified value is outside the suitable range for the item.
-11	Request Invalid	The request contained invalid information.
-12	Response Too Big	The response will not fit in the maximum response size.
-13	Decimal Place	The decimal place information is invalid (i.e. out of range of allowed values for a write).
-14	Invalid Param	Invalid parameter in the parameter channel.
-15	Invalid CMD	Invalid command.
-16	Invalid IP	Invalid IP address.
-17	Unknown Error	An unknown error happens.
-18 to -128	<i>Reserved</i>	<i>Reserved for future use.</i>

S.MM.PPP + 6 : Parameter value (MSW)

This parameter:

- Stores the most significant word of the value to be written to the destination parameter if the command is Write (3) or
- Stores the most significant word of the value read from the destination parameter if the command is Read (2) and the status is OK (3)

6.1.3 Menu 9 – Resources

S.09.001		Cyclic Tx Links Free	
Minimum	0	Maximum	255
Default		Units	
Type	8 Bit Volatile	Update Rate	Background write
Display Format	None	Decimal Places	0
Coding	RO, ND, NC, BU		

The number of available transmit cyclic links.

S.09.002		Cyclic Rx Links Free	
Minimum	0	Maximum	255
Default		Units	
Type	8 Bit Volatile	Update Rate	Background write
Display Format	None	Decimal Places	0
Coding	RO, ND, NC, BU		

The number of available receive cyclic links.

S.09.003		Fieldbus Links Free	
Minimum	0	Maximum	255
Default		Units	
Type	8 Bit Volatile	Update Rate	Background write
Display Format	None	Decimal Places	0
Coding	RO, ND, NC, BU		

The number of available transmit / receive process images for fieldbus protocols such as Ethernet/IP.

S.09.004		Cyclic Mappings Free	
Minimum	0	Maximum	255
Default		Units	
Type	8 Bit Volatile	Update Rate	Background write
Display Format	None	Decimal Places	0
Coding	RO, ND, NC, BU		

The number of available mappings in the system for use in cyclic links.

S.09.008		Background cycles per second	
Minimum	0	Maximum	65535
Default		Units	
Type	8 Bit Volatile	Update Rate	Background write
Display Format	None	Decimal Places	0
Coding	RO, ND, NC, BU, PT		

The background task cycles per second represents the number of times per second the background task is currently executing. The background task is responsible for cyclic data exchange with the drive. With more cyclic data mapped the cycle rate of the task will decrease.

S.09.010		Synchronous Task % Free	
Minimum	0	Maximum	255
Default		Units	%
Type	8 Bit Volatile	Update Rate	Background write
Display Format	None	Decimal Places	0
Coding	RO, ND, NC, BU		

Current resource available for the synchronous task.

S.09.020		Synchronous Task Worst % Free	
Minimum	0	Maximum	255
Default		Units	%
Type	8 Bit Volatile	Update Rate	Background write
Display Format	None	Decimal Places	0
Coding	RO, ND, NC, BU		

Worst case free resource of the synchronous task.

S.09.030		PCB Temperature	
Minimum	-128	Maximum	127
Default		Units	°C
Type	8 Bit Volatile	Update Rate	Background write
Display Format	None	Decimal Places	0
Coding	RO, ND, NC		

6.1.4 Menu 10 – Easy Mode Cyclic Data

The menus specified here allow up to 3 transmit and 3 receive cyclic links to be configured. Each receive link can have its own timeout configured with an additional custom action.

For greater control advanced cyclic links can be configured using the cyclic link editor within Machine Control Studio.

Base link parameters

Link	Profile	Link No.	Src/Dest Par	Par Count	Type	IP Address	Rate
Tx1	S.10.010	S.10.011	S.10.012	S.10.013	S.10.14	S.10.015*	S.10.016
Tx2	S.10.020	S.10.021	S.10.022	S.10.023	S.10.24	S.10.025*	S.10.026
Tx3	S.10.030	S.10.031	S.10.032	S.10.033	S.10.34	S.10.035*	S.10.036
Rx1	S.10.040	S.10.041	S.10.042	S.10.043	S.10.044	n/a	n/a
Rx2	S.10.050	S.10.051	S.10.052	S.10.053	S.10.054	n/a	n/a
Rx3	S.10.060	S.10.061	S.10.062	S.10.063	S.10.064	n/a	n/a

* Required if Type set to “unicast”

S.10.001		Enable	
Minimum	0	Maximum	1
Default	1	Units	
Type	1 Bit User Save	Update Rate	Background read
Display Format	None	Decimal Places	0
Coding	RW, BU		

This parameter is used to enable or disable the Easy Mode protocol interface.

S.10.002		Reset	
Minimum	0	Maximum	1
Default	0	Units	
Type	1 Bit Volatile	Update Rate	Background read
Display Format	None	Decimal Places	0
Coding	RW, NC		

This parameter is used to perform a warm reset of the protocol interface. When set and the protocol has reset, the parameter will be reset to zero (Off).

S.10.003		Default	
Minimum	0	Maximum	1
Default	0	Units	
Type	1 Bit Volatile	Update Rate	Read on reset
Display Format	None	Decimal Places	0
Coding	RW, NC		

This parameter allows the protocol to be defaulted to factory settings. This includes all of the protocol features, configuration, mappings and stored objects.

S.10.010		Tx1 Link Profile	
Minimum	0	Maximum	1
Default	0	Units	
Type	8 Bit User Save	Update Rate	Read on reset
Display Format	None	Decimal Places	0
Coding	RW, TE		

Value	Text	Description
0	Std	Standard link
1	Sync	Synchronized link

Used to select Tx1 as a standard or synchronous cyclic link.

S.10.011		Tx1 Link Number	
Minimum	0	Maximum	255
Default	0	Units	
Type	8 Bit User Save	Update Rate	Read on reset
Display Format	None	Decimal Places	0
Coding	RW, BU		

This parameter is used to set the link number (1 to 255) for the Tx1 link.

S.10.012		Tx1 Source Parameter	
Minimum	0 (Display:0.00.000)	Maximum	499999 (Display: 4.99.999)
Default	0 (Display:0.00.000)	Units	
Type	32 Bit User Save	Update Rate	Read on reset
Display Format	Slot Menu Param	Decimal Places	0
Coding	RW, PT, BU		

This parameter sets the source parameter for the Tx1 link.

S.10.013		Tx1 Parameter Count	
Minimum	0	Maximum	10
Default	0	Units	
Type	8 Bit User Save	Update Rate	Read on reset
Display Format	None	Decimal Places	0
Coding	RW, BU		

This parameter is used to set the number of contiguous parameters for the Tx1 link.

S.10.014		Tx1 Link Transmission Type	
Minimum	0	Maximum	5
Default	0	Units	
Type	8 Bit User Save	Update Rate	Read on reset
Display Format	None	Decimal Places	0
Coding	RW, TE, BU		

Value	Text	Description
0	Unicast	Link is unicast to the IP address specified
1	Broadcast	Link is broadcast (255.255.255.255)
2	Multicast1	Link is multicast to the IP address (239.255.0.1)
3	Multicast2	Link is multicast to the IP address (239.255.0.2)
4	Multicast3	Link is multicast to the IP address (239.255.0.3)
5	Multicast4	Link is multicast to the IP address (239.255.0.4)

This parameter specifies the type of transmission for the Tx1 link.

S.10.015		Tx1 Destination Address	
Minimum	0 (Display:0.0.0.0)	Maximum	4294967295 (Display: 255.255.255.255)
Default	0 (Display:0.0.0.0)	Units	
Type	32 Bit User Save	Update Rate	Read on reset
Display Format	IP Address	Decimal Places	0
Coding	RW, BU		

This parameter specifies the IP address of the destination device for the Tx1 link. If *Tx1 Link Transmission Type* (S.10.014) is set to either broadcast or one of the multicast settings this parameter will display the appropriate address.

NOTE This parameter value is not locked and may be changed by the user, if this value is changed to any of the multicast addresses (Multicast1, Multicast2, Multicast3 or Multicast4) or the broadcast address then *Tx1 Link Transmission Type* (S.10.014) will indicate the appropriate setting.

S.10.016		Tx1 Message Rate	
Minimum	0	Maximum	100
Default	0	Units	ms
Type	8 Bit User Save	Update Rate	Read on reset
Display Format	None	Decimal Places	0
Coding	RW, BU		

Defines, in milliseconds, the rate at which Tx1 Link will be transmitted. A value of zero disables the transmission of data.

S.10.019		Tx1 Link Status	
Minimum	-30	Maximum	2
Default	0	Units	
Type	8 Bit Volatile	Update Rate	Write on reset
Display Format	None	Decimal Places	0
Coding	RO, TE		

Value	Text	Description
-30	VLAN disabled	VLAN is required in order to guarantee timing in synchronous mode but it is disabled
-29	Reserved 29	Reserved for future use
-28	Reserved 28	Reserved for future use
-27	Reserved 27	Reserved for future use
-26	Reserved 26	Reserved for future use
-25	Reserved 25	Reserved for future use
-24	Reserved 24	Reserved for future use
-23	Reserved 23	Reserved for future use
-22	Invalid DST IP	Destination IP address is invalid
-21	SYNC unsupported	Sync link does not support mappings to other option parameters
-20	MEC offset	Incorrect MEC offset
-19	Invalid tx rate	Tx rate must be a factor of 1 second
-18	Too many mapping	The number of mapping items exceeds the range supported
-17	Link busy	The link specified is busy
-16	Invalid profile	The profile is invalid
-15	Invalid mapping	The mapped parameter does not exist
-14	Read only param	The mapped parameter is read only
-13	Msg mismatch	Link number and direction do not match
-12	Msg too long	Resulting message is too long
-11	Attrib NA	Attribute not available

Value	Text	Description
-10	Attrib RO	Attribute is read only
-9	Attrib missing	Attribute is missing
-8	Timeout	Timeout
-7	In error	The specified link is in error state
-6	Link num in use	The link number specified is already in use
-5	Not editable	The link specified is not editable
-4	Invalid link num	An invalid link number was specified
-3	Invalid args	Link number / argument zero or invalid
-2	Too many links	Maximum number of links has been reached
-1	Out of memory	Failed to allocate memory
0	OK	Configuration of link successful
1	Not running	Ok, not running
2	OK sync	Configuration of synchronous link successful

This reports the links status if it has been loaded. A **Reset (S.10.002)** is required to load any changes.

S.10.020		Tx2 Link Profile	
Minimum	0	Maximum	1
Default	0	Units	
Type	8 Bit User Save	Update Rate	Read on reset
Display Format	None	Decimal Places	0
Coding	RW, TE		

Value	Text	Description
0	Std	Standard link
1	Sync	Synchronized link

Used to select Tx2 as a standard or synchronous cyclic link.

S.10.021		Tx2 Link Number	
Minimum	0	Maximum	255
Default	0	Units	
Type	8 Bit User Save	Update Rate	Read on reset
Display Format	None	Decimal Places	0
Coding	RW, BU		

This parameter is used to set the link number (1 to 255) for the Tx2 link.

S.10.022		Tx2 Source Parameter	
Minimum	0 (Display: 0.00.000)	Maximum	499999 (Display: 4.99.999)
Default	0 (Display: 0.00.000)	Units	
Type	32 Bit User Save	Update Rate	Read on reset
Display Format	Slot Menu Param	Decimal Places	0
Coding	RW, PT, BU		

This parameter sets the source parameter for the Tx2 link.

S.10.023		Tx2 Parameter Count	
Minimum	0	Maximum	10
Default	0	Units	
Type	8 Bit User Save	Update Rate	Read on reset
Display Format	None	Decimal Places	0
Coding	RW, BU		

This parameter is used to set the number of contiguous parameters for the Tx2 link.

S.10.024		Tx2 Link Transmission Type	
Minimum	0	Maximum	5
Default	0	Units	
Type	8 Bit User Save	Update Rate	Read on reset
Display Format	None	Decimal Places	0
Coding	RW, TE, BU		

Value	Text	Description
0	Unicast	Link is unicast to the IP address specified
1	Broadcast	Link is broadcast (255.255.255.255)
2	Multicast1	Link is multicast to the IP address (239.255.0.1)
3	Multicast2	Link is multicast to the IP address (239.255.0.2)
4	Multicast3	Link is multicast to the IP address (239.255.0.3)
5	Multicast4	Link is multicast to the IP address (239.255.0.4)

This specifies the type of transmission for the Tx2 link.

S.10.025		Tx2 Destination Address	
Minimum	0 (Display:0.0.0.0)	Maximum	4294967295 (Display: 255.255.255.255)
Default	0 (Display:0.0.0.0)	Units	
Type	32 Bit User Save	Update Rate	Read on reset
Display Format	IP Address	Decimal Places	0
Coding	RW, BU		

This parameter specifies the IP address of the destination device for the Tx2 link. If *Tx2 Link Transmission Type* (**S.10.024**) is set to either broadcast or one of the multicast settings this parameter will display the appropriate address.

NOTE

This parameter value is not locked and may be changed by the user, if this value is changed to any of the multicast addresses (Multicast1, Multicast2, Multicast3 or Multicast4) or the broadcast address then *Tx2 Link Transmission Type* (**S.10.024**) will indicate the appropriate setting.

S.10.026		Tx2 Message Rate	
Minimum	0	Maximum	100
Default	0	Units	ms
Type	8 Bit User Save	Update Rate	Read on reset
Display Format	None	Decimal Places	0
Coding	RW, BU		

Defines, in milliseconds, the rate at which Tx2 Link will be transmitted. A value of zero disables the transmission of data.

S.10.029		Tx2 Link Status	
Minimum	-30	Maximum	2
Default	0	Units	
Type	8 Bit Volatile	Update Rate	Write on reset
Display Format	None	Decimal Places	0
Coding	RO, TE		

Safety information
Introduction
Mechanical installation
Electrical installation
Getting started
Parameters
Key features and Protocols
PC Applications
Security
Diagnostics
Glossary of terms
Index

Value	Text	Description
-30	VLAN disabled	VLAN is required in order to guarantee timing in synchronous mode but it is disabled
-29	Reserved 29	Reserved for future use
-28	Reserved 28	Reserved for future use
-27	Reserved 27	Reserved for future use
-26	Reserved 26	Reserved for future use
-25	Reserved 25	Reserved for future use
-24	Reserved 24	Reserved for future use
-23	Reserved 23	Reserved for future use
-22	Invalid DST IP	Destination IP address is invalid
-21	SYNC unsupported	Sync link does not support mappings to other option parameters
-20	MEC offset	Incorrect MEC offset
-19	Invalid tx rate	Tx rate must be a factor of 1 second
-18	Too many mapping	The number of mapping items exceeds the range supported
-17	Link busy	The link specified is busy
-16	Invalid profile	The profile is invalid
-15	Invalid mapping	The mapped parameter does not exist
-14	Read only param	The mapped parameter is read only
-13	Msg mismatch	Link number and direction do not match
-12	Msg too long	Resulting message is too long
-11	Attrib NA	Attribute not available
-10	Attrib RO	Attribute is read only
-9	Attrib missing	Attribute is missing
-8	Timeout	Timeout
-7	In error	The specified link is in error state
-6	Link num in use	The link number specified is already in use
-5	Not editable	The link specified is not editable
-4	Invalid link num	An invalid link number was specified
-3	Invalid args	Link number / argument zero or invalid
-2	Too many links	Maximum number of links has been reached
-1	Out of memory	Failed to allocate memory
0	OK	Configuration of link successful
1	Not running	Ok, not running
2	OK sync	Configuration of synchronous link successful

This parameter reports the link's status if it has been loaded. A *Reset (S.10.002)* is required to load any changes.

S.10.030		Tx3 Link Profile	
Minimum	0	Maximum	1
Default	0	Units	
Type	8 Bit User Save	Update Rate	Read on reset
Display Format	None	Decimal Places	0
Coding	RW, TE		

Value	Text	Description
0	Std	Standard link
1	Sync	Synchronized link

Used to select Tx3 as a standard or synchronous cyclic link.

S.10.031		Tx3 Link Number	
Minimum	0	Maximum	255
Default	0	Units	
Type	8 Bit User Save	Update Rate	Read on reset
Display Format	None	Decimal Places	0
Coding	RW, BU		

This parameter is used to set the link number (1 to 255) for the Tx3 link.

S.10.032		Tx3 Source Parameter	
Minimum	0 (Display: 0.00.000)	Maximum	499999 (Display: 4.99.999)
Default	0 (Display: 0.00.000)	Units	
Type	32 Bit User Save	Update Rate	Read on reset
Display Format	Slot Menu Param	Decimal Places	0
Coding	RW, PT, BU		

This parameter sets the source parameter for the Tx3 link.

S.10.033		Tx3 Parameter Count	
Minimum	0	Maximum	10
Default	0	Units	
Type	8 Bit User Save	Update Rate	Read on reset
Display Format	None	Decimal Places	0
Coding	RW, BU		

This parameter is used to set the number of contiguous parameters for the Tx3 link.

Safety information
Introduction
Mechanical installation
Electrical installation
Getting started
Parameters
Key features and protocols
PC Applications
Security
Diagnostics
Glossary of terms
Index

S.10.034		Tx3 Link Transmission Type	
Minimum	0	Maximum	5
Default	0	Units	
Type	8 Bit User Save	Update Rate	Read on reset
Display Format	None	Decimal Places	0
Coding	RW, TE, BU		

Value	Text	Description
0	Unicast	Link is unicast to the IP address specified
1	Broadcast	Link is broadcast (255.255.255.255)
2	Multicast1	Link is multicast to the IP address (239.255.0.1)
3	Multicast2	Link is multicast to the IP address (239.255.0.2)
4	Multicast3	Link is multicast to the IP address (239.255.0.3)
5	Multicast4	Link is multicast to the IP address (239.255.0.4)

This parameter specifies the type of transmission for the Tx3 link.

S.10.035		Tx3 Destination Address	
Minimum	0 (Display:0.0.0.0)	Maximum	4294967295 (Display: 255.255.255.255)
Default	0 (Display:0.0.0.0)	Units	
Type	32 Bit User Save	Update Rate	Read on reset
Display Format	IP Address	Decimal Places	0
Coding	RW, BU		

This parameter specifies the IP address of the destination device for the Tx3 link. If *Tx3 Link Transmission Type* (**S.10.034**) is set to either broadcast or one of the multicast settings this parameter will display the appropriate address.

NOTE This parameter value is not locked and may be changed by the user, if this value is changed to any of the multicast addresses (Multicast1, Multicast2, Multicast3 or Multicast4) or the broadcast address then *Tx3 Link Transmission Type* (**S.10.034**) will indicate the appropriate setting.

S.10.036		Tx3 Message Rate	
Minimum	0	Maximum	100
Default	0	Units	ms
Type	8 Bit User Save	Update Rate	Read on reset
Display Format	None	Decimal Places	0
Coding	RW, BU		

Defines, in milliseconds, the rate at which Tx3 Link will be transmitted. A value of zero disables the transmission of data.

S.10.039		Tx3 Link Status	
Minimum	-30	Maximum	2
Default	0	Units	
Type	8 Bit Volatile	Update Rate	Write on reset
Display Format	None	Decimal Places	0
Coding	RO, TE		

Value	Text	Description
-30	VLAN disabled	VLAN is required in order to guarantee timing in synchronous mode but it is disabled
-29	Reserved 29	Reserved for future use
-28	Reserved 28	Reserved for future use
-27	Reserved 27	Reserved for future use
-26	Reserved 26	Reserved for future use
-25	Reserved 25	Reserved for future use
-24	Reserved 24	Reserved for future use
-23	Reserved 23	Reserved for future use
-22	Invalid DST IP	Destination IP address is invalid
-21	SYNC unsupported	Sync link does not support mappings to other option parameters
-20	MEC offset	Incorrect MEC offset
-19	Invalid tx rate	Tx rate must be a factor of 1 second
-18	Too many mapping	The number of mapping items exceeds the range supported
-17	Link busy	The link specified is busy
-16	Invalid profile	The profile is invalid
-15	Invalid mapping	The mapped parameter does not exist
-14	Read only param	The mapped parameter is read only
-13	Msg mismatch	Link number and direction do not match
-12	Msg too long	Resulting message is too long
-11	Attrib NA	Attribute not available
-10	Attrib RO	Attribute is read only
-9	Attrib missing	Attribute is missing
-8	Timeout	Timeout
-7	In error	The specified link is in error state
-6	Link num in use	The link number specified is already in use
-5	Not editable	The link specified is not editable
-4	Invalid link num	An invalid link number was specified

Safety information
Introduction
Mechanical installation
Electrical installation
Getting started
Parameters
Key features and protocols
PC Applications
Security
Diagnostics
Glossary of terms
Index

Value	Text	Description
-3	Invalid args	Link number / argument zero or invalid
-2	Too many links	Maximum number of links has been reached
-1	Out of memory	Failed to allocate memory
0	OK	Configuration of link successful
1	Not running	Ok, not running
2	OK sync	Configuration of synchronous link successful

This parameter reports the link's status if it has been loaded. A *Reset (S.10.002)* is required to load any changes.

S.10.040		Rx1 Link Profile	
Minimum	0	Maximum	1
Default	0	Units	
Type	8 Bit User Save	Update Rate	Read on reset
Display Format	None	Decimal Places	0
Coding	RW, TE		

Value	Text	Description
0	Std	Standard link
1	Sync	Synchronized link

Used to select Rx1 as a standard or synchronous cyclic link.

S.10.041		Rx1 Link Number	
Minimum	0	Maximum	255
Default	0	Units	
Type	8 Bit User Save	Update Rate	Read on reset
Display Format	None	Decimal Places	0
Coding	RW, BU		

This parameter is used to set the link number (1 to 255) for the Rx1 link.

S.10.042		Rx1 Destination Parameter	
Minimum	0 (Display: 0.00.000)	Maximum	499999 (Display: 4.99.999)
Default	0 (Display: 0.00.000)	Units	
Type	32 Bit User Save	Update Rate	Read on reset
Display Format	Slot Menu Param	Decimal Places	0
Coding	RW, BU		

This parameter sets the destination parameter for the Rx1 link.

S.10.043		Rx1 Parameter Count	
Minimum	0	Maximum	10
Default	0	Units	
Type	8 Bit User Save	Update Rate	Read on reset
Display Format	None	Decimal Places	0
Coding	RW, BU		

This parameter is used to set the number of contiguous parameters for the Rx1 link.

S.10.044		Rx1 Source Type	
Minimum	0	Maximum	5
Default	0	Units	
Type	8 Bit User Save	Update Rate	Read on reset
Display Format	None	Decimal Places	0
Coding	RW, TE, BU		

Value	Text	Description
0	Direct	Link is unicast or broadcast
1	Multicast1	Link is multicast to the IP address
2	Multicast2	Link is multicast to the IP address
3	Multicast3	Link is multicast to the IP address
4	Multicast4	Link is multicast to the IP address
5	Local	Link will receive from local transmit link

This specifies the type of transmission for the Rx1 link.

S.10.045		Rx1 Timeout	
Minimum	0	Maximum	65535
Default	100	Units	ms
Type	16 Bit User Save	Update Rate	Read on reset
Display Format	None	Decimal Places	0
Coding	RW, BU		

This parameter specifies the watchdog timer for the Rx1 link. If no cyclic data is received on the Rx1 link the action taken will be determined by the setting in *Rx1 Timeout Action* (**S.10.046**).

NOTE It is good system design to allow for some message loss by setting the timeout duration to be greater than the transmit period by a factor of 2 or more.

S.10.046		Rx1 Timeout Action	
Minimum	0	Maximum	2
Default	0	Units	
Type	8 Bit User Save	Update Rate	Read on reset
Display Format	None	Decimal Places	0
Coding	RW, TE, BU		

Value	Text	Description
0	Trip	Trip drive with Slx.Er and sub-trip code 106 (Cyclic Timeout)
1	Clear output	PLC output parameters will have their values set to zero
2	Hold last	Hold the last value in output parameters

Defines the action to be taken for a timeout on the Rx1 link.

S.10.047		Rx1 Timeout Event Destination	
Minimum	0	Maximum	4
Default	0	Units	
Type	8 Bit User save	Update Rate	Read on reset
Display Format	None	Decimal Places	0
Coding	RW, TE, BU		

Value	Text	Description
0	This slot	Trigger module event in this slot
1	Slot 1	Trigger module event in slot 1
2	Slot 2	Trigger module event in slot 2
3	Slot 3	Trigger module event in slot 3
4	Slot 4	Trigger module event in slot 4

This parameter defines the slot in which an event will occur if a cyclic data timeout occurs on the Rx1 link.

NOTE This feature is not yet implemented.

S.10.048		Rx1 Timeout Event Type	
Minimum	0	Maximum	4
Default	0	Units	
Type	8 Bit User save	Update Rate	Read on reset
Display Format	None	Decimal Places	0
Coding	RW, TE, BU		

Value	Text	Description
0	No Event	No event
1	Event	Trigger module event
2	Event 1	Trigger module event 1
3	Event 2	Trigger module event 2
4	Event 3	Trigger module event 3

Defines the event to trigger in the given destination, as specified in *Rx1 Timeout Event Destination* (**S.10.047**), if a cyclic data timeout occurs on the Rx1 link.

NOTE This feature is not yet implemented.

S.10.049		Rx1 Link Status	
Minimum	-30	Maximum	2
Default	0	Units	
Type	8 Bit Volatile	Update Rate	Write on reset
Display Format	None	Decimal Places	0
Coding	RO, TE		

Value	Text	Description
-30	VLAN disabled	VLAN is required in order to guarantee timing in synchronous mode but it is disabled
-29	Reserved 29	Reserved for future use
-28	Reserved 28	Reserved for future use
-27	Reserved 27	Reserved for future use
-26	Reserved 26	Reserved for future use
-25	Reserved 25	Reserved for future use
-24	Reserved 24	Reserved for future use
-23	Reserved 23	Reserved for future use
-22	Invalid DST IP	Destination IP address is invalid
-21	SYNC unsupported	Sync link does not support mappings to other option parameters
-20	MEC offset	Incorrect MEC offset
-19	Invalid tx rate	Tx rate must be a factor of 1 second
-18	Too many mapping	The number of mapping items exceeds the range supported
-17	Link busy	The link specified is busy
-16	Invalid profile	The profile is invalid
-15	Invalid mapping	The mapped parameter does not exist
-14	Read only param	The mapped parameter is read only

Value	Text	Description
-13	Msg mismatch	Link number and direction do not match
-12	Msg too long	Resulting message is too long
-11	Attrib NA	Attribute not available
-10	Attrib RO	Attribute is read only
-9	Attrib missing	Attribute is missing
-8	Timeout	Timeout
-7	In error	The specified link is in error state
-6	Link num in use	The link number specified is already in use
-5	Not editable	The link specified is not editable
-4	Invalid link num	An invalid link number was specified
-3	Invalid args	Link number / argument zero or invalid
-2	Too many links	Maximum number of links has been reached
-1	Out of memory	Failed to allocate memory
0	OK	Configuration of link successful
1	Not running	Ok, not running
2	OK sync	Configuration of synchronous link successful

This parameter reports the link's status if it has been loaded. A **Reset (S.10.002)** is required to load any changes.

S.10.050		Rx2 Link Profile	
Minimum	0	Maximum	1
Default	0	Units	
Type	8 Bit User Save	Update Rate	Read on reset
Display Format	None	Decimal Places	0
Coding	RW, TE		

Value	Text	Description
0	Std	Standard link
1	Sync	Synchronized link

Used to select Rx2 as a standard or synchronous cyclic link.

S.10.051		Rx2 Link Number	
Minimum	0	Maximum	255
Default	0	Units	
Type	8 Bit User Save	Update Rate	Read on reset
Display Format	None	Decimal Places	0
Coding	RW, BU		

This parameter is used to set the link number (1 to 255) for the Rx2 link.

S.10.052		Rx2 Destination Parameter	
Minimum	0 (Display: 0.00.000)	Maximum	499999 (Display: 4.99.999)
Default	0 (Display: 0.00.000)	Units	
Type	32 Bit User Save	Update Rate	Read on reset
Display Format	Slot Menu Param	Decimal Places	0
Coding	RW, PT, BU		

This parameter sets the destination parameter for the Rx2 link.

S.10.053		Rx2 Parameter Count	
Minimum	0	Maximum	10
Default	0	Units	
Type	8 Bit User Save	Update Rate	Read on reset
Display Format	None	Decimal Places	0
Coding	RW, BU		

This is used to set the number of contiguous parameters for the Rx2 link.

S.10.054		Rx2 Source Type	
Minimum	0	Maximum	5
Default	0	Units	
Type	8 Bit User Save	Update Rate	Read on reset
Display Format	None	Decimal Places	0
Coding	RW, TE, BU		

Value	Text	Description
0	Direct	Link is unicast or broadcast
1	Multicast1	Link is multicast to the IP address
2	Multicast2	Link is multicast to the IP address
3	Multicast3	Link is multicast to the IP address
4	Multicast4	Link is multicast to the IP address
5	Local	Link will receive from local transmit link

This parameter specifies the type of transmission for the Rx2 link.

S.10.055		Rx2 Timeout	
Minimum	0	Maximum	65535
Default	100	Units	ms
Type	16 Bit User Save	Update Rate	Read on reset
Display Format	None	Decimal Places	0
Coding	RW, BU		

This parameter specifies the watchdog timer for the Rx2 link. If no cyclic data is received on the Rx2 link the action taken will be determined by the setting in *Rx2 Timeout Action (S.10.056)*.

NOTE It is good system design to allow for some message loss by setting the timeout duration to be greater than the transmit period by a factor of 2 or more.

S.10.056		Rx2 Timeout Action	
Minimum	0	Maximum	2
Default	0	Units	
Type	8 Bit User save	Update Rate	Read on reset
Display Format	None	Decimal Places	0
Coding	RW, TE, BU		

Value	Text	Description
0	Trip	Trip drive with Slx.Er and sub-trip code 106 (Cyclic Timeout)
1	Clear output	PLC output parameters will have their values set to zero
2	Hold last	Hold the last value in output parameters

Defines the action to be taken for a timeout on the Rx2 link.

S.10.057		Rx2 Timeout Event Destination	
Minimum	0	Maximum	4
Default	0	Units	
Type	8 Bit User save	Update Rate	Read on reset
Display Format	None	Decimal Places	0
Coding	RW, TE, BU		

Value	Text	Description
0	This slot	Trigger module event in this slot
1	Slot 1	Trigger module event in slot 1
2	Slot 2	Trigger module event in slot 2
3	Slot 3	Trigger module event in slot 3
4	Slot 4	Trigger module event in slot 4

This parameter defines the slot in which an event will occur if a cyclic data timeout occurs on the Rx2 link.

NOTE This feature is not yet implemented.

S.10.058		Rx2 Timeout Event Type	
Minimum	0	Maximum	4
Default	0	Units	
Type	8 Bit User save	Update Rate	Read on reset
Display Format	None	Decimal Places	0
Coding	RW, TE, BU		

Value	Text	Description
0	No Event	No event
1	Event	Trigger module event
2	Event 1	Trigger module event 1
3	Event 2	Trigger module event 2
4	Event 3	Trigger module event 3

Defines the event to trigger in the given destination, as specified in *Rx2 Timeout Event Destination (S.10.057)*, if a cyclic data timeout occurs on the Rx2 link.

NOTE This feature is not yet implemented.

S.10.059		Rx2 Link Status	
Minimum	-30	Maximum	2
Default	0	Units	
Type	8 Bit Volatile	Update Rate	Write on reset
Display Format	None	Decimal Places	0
Coding	RO, TE		

Safety information
Introduction
Mechanical installation
Electrical installation
Getting started
Parameters
Key features and Protocols
PC Applications
Security
Diagnostics
Glossary of terms
Index

Value	Text	Description
-30	VLAN disabled	VLAN is required in order to guarantee timing in synchronous mode but it is disabled
-29	Reserved 29	Reserved for future use
-28	Reserved 28	Reserved for future use
-27	Reserved 27	Reserved for future use
-26	Reserved 26	Reserved for future use
-25	Reserved 25	Reserved for future use
-24	Reserved 24	Reserved for future use
-23	Reserved 23	Reserved for future use
-22	Invalid DST IP	Destination IP address is invalid
-21	SYNC unsupported	Sync link does not support mappings to other option parameters
-20	MEC offset	Incorrect MEC offset
-19	Invalid tx rate	Tx rate must be a factor of 1 second
-18	Too many mapping	The number of mapping items exceeds the range supported
-17	Link busy	The link specified is busy
-16	Invalid profile	The profile is invalid
-15	Invalid mapping	The mapped parameter does not exist
-14	Read only param	The mapped parameter is read only
-13	Msg mismatch	Link number and direction do not match
-12	Msg too long	Resulting message is too long
-11	Attrib NA	Attribute not available
-10	Attrib RO	Attribute is read only
-9	Attrib missing	Attribute is missing
-8	Timeout	Timeout
-7	In error	The specified link is in error state
-6	Link num in use	The link number specified is already in use
-5	Not editable	The link specified is not editable
-4	Invalid link num	An invalid link number was specified
-3	Invalid args	Link number / argument zero or invalid
-2	Too many links	Maximum number of links has been reached
-1	Out of memory	Failed to allocate memory
0	OK	Configuration of link successful
1	Not running	Ok, not running
2	OK sync	Configuration of synchronous link successful

This parameter reports the link's status if it has been loaded. A *Reset (S.10.002)* is required to load any changes.

S.10.060		Rx3 Link Profile	
Minimum	0	Maximum	1
Default	0	Units	
Type	8 Bit User Save	Update Rate	Read on reset
Display Format	None	Decimal Places	0
Coding	RW, TE		

Value	Text	Description
0	Std	Standard link
1	Sync	Synchronized link

Used to select Rx3 as a standard or synchronous cyclic link.

S.10.061		Rx3 Link Number	
Minimum	0	Maximum	255
Default	0	Units	
Type	8 Bit User Save	Update Rate	Read on reset
Display Format	None	Decimal Places	0
Coding	RW, BU		

This parameter is used to set the link number (1 to 255) for the Rx3 link.

S.10.062		Rx3 Destination Parameter	
Minimum	0 (Display: 0.00.000)	Maximum	499999 (Display: 4.99.999)
Default	0 (Display: 0.00.000)	Units	
Type	32 Bit User Save	Update Rate	Read on reset
Display Format	Slot Menu Param	Decimal Places	0
Coding	RW, PT, BU		

This parameter sets the destination parameter for the Rx3 link.

S.10.063		Rx3 Parameter Count	
Minimum	0	Maximum	10
Default	0	Units	
Type	8 Bit User Save	Update Rate	Read on reset
Display Format	None	Decimal Places	0
Coding	RW, BU		

This parameter is used to set the number of contiguous parameters for the Rx3 link.

Safety information
Introduction
Mechanical installation
Electrical installation
Getting started
Parameters
Key features and protocols
PC Applications
Security
Diagnostics
Glossary of terms
Index

S.10.064		Rx3 Source Type	
Minimum	0	Maximum	5
Default	0	Units	
Type	8 Bit User Save	Update Rate	Read on reset
Display Format	None	Decimal Places	0
Coding	RW, TE, BU		

Value	Text	Description
0	Direct	Link is unicast or broadcast
1	Multicast1	Link is multicast to the IP address
2	Multicast2	Link is multicast to the IP address
3	Multicast3	Link is multicast to the IP address
4	Multicast4	Link is multicast to the IP address
5	Local	Link will receive from local transmit link

This parameter specifies the type of transmission for the Rx3 link.

S.10.065		Rx3 Timeout	
Minimum	0	Maximum	65535
Default	100	Units	ms
Type	16 Bit User Save	Update Rate	Read on reset
Display Format	None	Decimal Places	0
Coding	RW, BU		

This parameter specifies the watchdog timer for the Rx3 link. If no cyclic data is received on the Rx3 link the action taken will be determined by the setting in *Rx3 Timeout Action* (**S.10.066**).

NOTE It is good system design to allow for some message loss by setting the timeout duration to be greater than the transmit period by a factor of 2 or more.

S.10.066		Rx3 Timeout Action	
Minimum	0	Maximum	2
Default	0	Units	
Type	8 Bit User Save	Update Rate	Read on reset
Display Format	None	Decimal Places	0
Coding	RW, BU		

Value	Text	Description
0	Trip	Trip drive with Six.Er and sub-trip code
1	Clear output	PLC output parameters will have their values set to zero
2	Hold last	Hold the last value in output parameters

Defines the action to be taken for a timeout on the Rx3 link.

S.10.067		Rx3 Timeout Event Destination	
Minimum	0	Maximum	4
Default	0	Units	
Type	8 Bit User save	Update Rate	Read on reset
Display Format	None	Decimal Places	0
Coding	RW, TE, BU		

Value	Text	Description
0	This slot	Trigger module event in this slot
1	Slot 1	Trigger module event in slot 1
2	Slot 2	Trigger module event in slot 2
3	Slot 3	Trigger module event in slot 3
4	Slot 4	Trigger module event in slot 4

This parameter defines the slot in which an event will occur if a cyclic data timeout occurs on the Rx3 link.

NOTE This feature is not yet implemented.

S.10.068		Rx3 Timeout Event Type	
Minimum	0	Maximum	4
Default	0	Units	
Type	8 Bit User save	Update Rate	Read on reset
Display Format	None	Decimal Places	0
Coding	RW, TE, BU		

Value	Text	Description
0	No Event	No event
1	Event	Trigger module event
2	Event 1	Trigger module event 1
3	Event 2	Trigger module event 2
4	Event 3	Trigger module event 3

Defines the event to trigger in the given destination, as specified in *Rx3 Timeout Event Destination* (**S.10.067**), if a cyclic data timeout occurs on the Rx3 link.

NOTE This feature is not yet implemented.

S.10.069		Rx3 Link Status	
Minimum	-30	Maximum	2
Default	0	Units	
Type	8 Bit Volatile	Update Rate	Write on reset
Display Format	None	Decimal Places	0
Coding	RO, TE		

Value	Text	Description
-30	VLAN disabled	VLAN is required in order to guarantee timing in synchronous mode but it is disabled
-29	Reserved 29	Reserved for future use
-28	Reserved 28	Reserved for future use
-27	Reserved 27	Reserved for future use
-26	Reserved 26	Reserved for future use
-25	Reserved 25	Reserved for future use
-24	Reserved 24	Reserved for future use
-23	Reserved 23	Reserved for future use
-22	Invalid DST IP	Destination IP address is invalid
-21	SYNC unsupported	Sync link does not support mappings to other option parameters
-20	MEC offset	Incorrect MEC offset
-19	Invalid tx rate	Tx rate must be a factor of 1 second
-18	Too many mapping	The number of mapping items exceeds the range supported
-17	Link busy	The link specified is busy
-16	Invalid profile	The profile is invalid
-15	Invalid mapping	The mapped parameter does not exist
-14	Read only param	The mapped parameter is read only
-13	Msg mismatch	Link number and direction do not match
-12	Msg too long	Resulting message is too long
-11	Attrib NA	Attribute not available
-10	Attrib RO	Attribute is read only
-9	Attrib missing	Attribute is missing
-8	Timeout	Timeout
-7	In error	The specified link is in error state
-6	Link num in use	The link number specified is already in use
-5	Not editable	The link specified is not editable
-4	Invalid link num	An invalid link number was specified

Value	Text	Description
-3	Invalid args	Link number / argument zero or invalid
-2	Too many links	Maximum number of links has been reached
-1	Out of memory	Failed to allocate memory
0	OK	Configuration of link successful
1	Not running	Ok, not running
2	OK sync	Configuration of synchronous link successful

This parameter reports the link's status if it has been loaded. A *Reset (S.10.002)* is required to load any changes.

6.1.5 Menu 11 – Synchronization

S.11.001		Preferred Sync Master	
Minimum	0	Maximum	4
Default	1	Units	
Type	8 Bit User Save	Update Rate	Read on reset
Display Format	None	Decimal Places	0
Coding	RW, BU		

This Ethernet interface will be preferred as the grandmaster over others with higher preferred values or none specified. A value of zero will ensure that the Ethernet interface will not become grandmaster (making the Ethernet interface act as an IEEE 1588 slave device only). If more than one Ethernet interface has the same preferred value only one will be chosen as the grandmaster using the IEEE 1588 BMC algorithm.

The parameter does not guarantee that the Ethernet interface will become grandmaster but a value of zero guarantees that the Ethernet interface will not become a grandmaster.

S.11.002		Master Clock Domain	
Minimum	0	Maximum	3
Default	0	Units	
Type	8 Bit User Save	Update Rate	Read on reset
Display Format	None	Decimal Places	0
Coding	RW, BU		

Specifies the clock domain for the Ethernet interface to act as a grandmaster clock.

S.11.005		Grandmaster MAC Address	
Minimum	0 (Display: 00:00:00:00:00:00)	Maximum	18446744073709551615 (Display: FF:FF:FF:FF:FF:FF)
Default		Units	
Type	64 Bit Volatile	Update Rate	Background write
Display Format	MAC Address	Decimal Places	0
Coding	RO, ND, NC, PT, BU		

This parameter displays the MAC address, as a 64-bit hexadecimal value, of the

synchronization grandmaster (if there is a grandmaster).

S.11.006		Synchronisation Jitter From Grandmaster	
Minimum	-2147483648	Maximum	2147483647
Default		Units	ns
Type	32 Bit Volatile	Update Rate	Written every 500ms
Display Format	None	Decimal Places	0
Coding	RO, ND, NC, PT		

This parameter displays the synchronization jitter in nanoseconds. The value is filtered to be human readable.

S.11.007		Synchronisation Jitter Threshold	
Minimum	500	Maximum	1000000
Default	1000	Units	ns
Type	32 Bit User Save	Update Rate	Read on reset
Display Format	None	Decimal Places	0
Coding	RW, BU		

Sets the application tolerable clock jitter in ns from the grandmaster. If *Synchronisation Jitter From Grandmaster* (**S.11.006**) is within the tolerance the local clock is used and *Module Synchronised Flag* (**S.11.008**) is set to 1 and synchronized cyclic data links will be processed.

S.11.008		Module Synchronised Flag	
Minimum	0	Maximum	1
Default	0	Units	
Type	1 Bit Volatile	Update Rate	Written every 10ms
Display Format	None	Decimal Places	0
Coding	RO		

This parameter displays the module's synchronization status. 1 = Synchronized, 0 = Not synchronized.

S.11.009		Inhibit Drive Synchronisation	
Minimum	0	Maximum	1
Default	0	Units	
Type	1 Bit User Save	Update Rate	Immediate
Display Format	None	Decimal Places	0
Coding	RW		

This parameter controls whether the module synchronizes the OPT_SYNC with the network grandmaster. A value of ON inhibits this.

S.11.010		PTP Date	
Minimum	0 (Display: 00-00-00)	Maximum	311299 (Display: 31-12-99)
Default		Units	
Type	32 Bit Volatile	Update Rate	Written every 500 ms
Display Format	Date	Decimal Places	0
Coding	RO, ND, NC, PT, BU		

This parameter displays the current date. If the module has no time source it will display the date based on its power-up date of 1st January 1970.

S.11.011		PTP Time	
Minimum	0 (Display: 00:00:00)	Maximum	235959 (Display: 23:59:59)
Default		Units	
Type	32 Bit Volatile	Update Rate	Written every 500 ms
Display Format	Time	Decimal Places	0
Coding	RO, ND, NC, PT, BU		

This parameter displays the current time. If the module has no time source it will display the time based on its power-up time.

S.11.016		PTP Sync Rate	
Minimum	-4	Maximum	0
Default	-4	Units	
Type	8 Bit User Save	Update Rate	Read on reset
Display Format	None	Decimal Places	0
Coding	RW		

This parameter controls the rate at which PTP Sync frames are sent. The message rate is determined by raising 2 to the power of this parameter. E.g the default value here of -4 results in sixteen sync messages per second.

S.11.017		In sync window length	
Minimum	3	Maximum	255
Default	20	Units	s
Type	8 Bit User Save	Update Rate	Read on reset
Display Format	None	Decimal Places	0
Coding	RW, BU		

Duration that the jitter (*Synchronisation Jitter From Grandmaster (S.11.006)*) must be below the jitter threshold for before the in sync flag (*Module Synchronised Flag (S.11.008)*) is set.

For a system the duration depends upon the number of IEEE1588 capable master devices on the network. To use lower values here the number of devices which are capable of acting as a synchronization master must be kept as low as possible by setting *Preferred Sync Master (S.11.001)* to 0 on all interfaces except those which may be master.

S.11.020		Network Error Count	
Minimum	0	Maximum	4294967295
Default		Units	
Type	32 Bit Volatile	Update Rate	Written every 500 ms
Display Format	None	Decimal Places	0
Coding	RO, ND, NC, PT, BU		

The parameter displays a count of network errors since startup. It can be used as an indication of a problem.

S.11.022		Interoption Sync Status	
Minimum	0	Maximum	2
Default		Units	
Type	8 Bit Volatile	Update Rate	Background
Display Format	None	Decimal Places	0
Coding	RO, TE, ND, NC, PT, BU		

Value	Text	Description
0	MASTER	The module is master but not producing
1	PRODUCER	The module is master and producing
2	INDEPENDENT	The module is not master

This module does not support Slave mode.

S.11.030		Easy Mode Maximum Network Delay	
Minimum	1	Maximum	100
Default	3	Units	ms
Type	8 Bit User Save	Update Rate	Read on reset
Display Format	None	Decimal Places	0
Coding	RW, BU		

This parameter defines the allowable network delay (in milliseconds) for the Easy Mode synchronous transmit cyclic links to arrive at their destination.

S.11.040		Rx1 Late Synchronisation Frame Action	
Minimum	1	Maximum	3
Default	1	Units	
Type	8 Bit User Save	Update Rate	Read on reset
Display Format	None	Decimal Places	0
Coding	RW, TE, BU		

Value	Text	Description
1	Trip	Trip drive with Slx.Er and sub-trip code
2	Do not use	The data is ignored
3	Use	The data is used immediately

This parameter defines the action to be taken when a late synchronized frame is received on the Rx1 link.

S.11.041		Rx1 Late Synchronisation Frame Destination	
Minimum	0	Maximum	4
Default	0	Units	
Type	8 Bit User Save	Update Rate	Read on reset
Display Format	None	Decimal Places	0
Coding	RW, TE, BU		

Value	Text	Description
0	This slot	Trigger module event in this slot
1	Slot 1	Trigger module event in slot 1
2	Slot 2	Trigger module event in slot 2
3	Slot 3	Trigger module event in slot 3
4	Slot 4	Trigger module event in slot 4

Defines the destination (slot) to trigger the event when a late synchronized frame is received on the Rx1 link.

NOTE This feature is not yet implemented.

S.11.042		Rx1 Late Synchronisation Frame Event	
Minimum	0	Maximum	4
Default	0	Units	
Type	8 Bit User Save	Update Rate	Read on reset
Display Format	None	Decimal Places	0
Coding	RW, TE, BU		

Value	Text	Description
0	No Event	No event
1	Event	Trigger module event
2	Event 1	Trigger module event 1
3	Event 2	Trigger module event 2
4	Event 3	Trigger module event 3

Defines the event number to trigger in the given destination (slot) when a late synchronized frame is received on the Rx1 link.

NOTE This feature is not yet implemented.

S.11.050		Rx2 Late Synchronisation Frame Action	
Minimum	1	Maximum	3
Default	1	Units	
Type	8 Bit User Save	Update Rate	Read on reset
Display Format	None	Decimal Places	0
Coding	RW, TE, BU		

Value	Text	Description
1	Trip	Trip drive with Slx.Er and sub-trip code
2	Do not use	The data is ignored
3	Use	The data is used immediately

This parameter defines the action to be taken when a late synchronized frame is received on the Rx2 link.

S.11.051		Rx2 Late Synchronisation Frame Destination	
Minimum	0	Maximum	4
Default	0	Units	
Type	8 Bit User Save	Update Rate	Read on reset
Display Format	None	Decimal Places	0
Coding	RW, TE, BU		

Value	Text	Description
0	This slot	Trigger module event in this slot
1	Slot 1	Trigger module event in slot 1
2	Slot 2	Trigger module event in slot 2
3	Slot 3	Trigger module event in slot 3
4	Slot 4	Trigger module event in slot 4

Defines the destination (slot) to trigger the event when a late synchronized frame is received on the Rx2 link.

NOTE This feature is not yet implemented.

S.11.052		Rx2 Late Synchronisation Frame Event	
Minimum	0	Maximum	4
Default	0	Units	
Type	8 Bit User Save	Update Rate	Read on reset
Display Format	None	Decimal Places	0
Coding	RW, TE, BU		

Value	Text	Description
0	No Event	No event
1	Event	Trigger module event
2	Event 1	Trigger module event 1
3	Event 2	Trigger module event 2
4	Event 3	Trigger module event 3

Defines the event number to trigger in the given destination (slot) when a late synchronized frame is received on the Rx2 link.

NOTE This feature is not yet implemented.

S.11.060		Rx3 Late Synchronisation Frame Action	
Minimum	1	Maximum	3
Default	1	Units	
Type	8 Bit User Save	Update Rate	Read on reset
Display Format	None	Decimal Places	0
Coding	RW, TE, BU		

Value	Text	Description
1	Trip	Trip drive with Slx.Er and sub-trip code
2	Do not use	The data is ignored
3	Use	The data is used immediately

This parameter defines the action to be taken when a late synchronized frame is received on the Rx3 link.

Safety information
Introduction
Mechanical installation
Electrical installation
Getting started
Parameters
Key features and Protocols
PC Applications
Security
Diagnostics
Glossary of terms
Index

S.11.061		Rx3 Late Synchronisation Frame Destination	
Minimum	0	Maximum	4
Default	0	Units	
Type	8 Bit User Save	Update Rate	Read on reset
Display Format	None	Decimal Places	0
Coding	RW, TE, BU		

Value	Text	Description
0	This slot	Trigger module event in this slot
1	Slot 1	Trigger module event in slot 1
2	Slot 2	Trigger module event in slot 2
3	Slot 3	Trigger module event in slot 3
4	Slot 4	Trigger module event in slot 4

Defines the destination (slot) to trigger the event when a late synchronized frame is received on the Rx3 link.

NOTE This feature is not yet implemented.

S.11.062		Rx3 Late Synchronisation Frame Event	
Minimum	0	Maximum	4
Default	0	Units	
Type	8 Bit User Save	Update Rate	Read on reset
Display Format	None	Decimal Places	0
Coding	RW, TE, BU		

Value	Text	Description
0	No Event	No event
1	Event	Trigger module event
2	Event 1	Trigger module event 1
3	Event 2	Trigger module event 2
4	Event 3	Trigger module event 3

Defines the event number to trigger in the given destination (slot) when a late synchronized frame is received on the Rx3 link.

NOTE This feature is not yet implemented.

6.1.6 Menu 15 – Modbus

S.15.001		Enable	
Minimum	0	Maximum	1
Default	1	Units	
Type	1 Bit User Save	Update Rate	Background read
Display Format	None	Decimal Places	0
Coding	RW, BU		

This parameter is used to enable or disable Modbus master and slave functionality.

S.15.002		Reset	
Minimum	0	Maximum	1
Default	0	Units	
Type	1 Bit Volatile	Update Rate	Background read; written to 0 on initialization
Display Format	None	Decimal Places	0
Coding	RW, NC		

This parameter is used to perform a warm reset of the protocol interface. When set and the protocol has reset, the parameter will be reset to zero (Off).

S.15.003		Default	
Minimum	0	Maximum	1
Default	0	Units	
Type	1 Bit Volatile	Update Rate	On module reset, protocol interface reset or protocol enable
Display Format	None	Decimal Places	0
Coding	RW, NC		

This parameter allows the protocol to be defaulted to factory settings. This includes all of the protocol features, configuration, mappings and stored objects.

S.15.004		Modbus Configuration Error	
Minimum	0	Maximum	3
Default		Units	
Type	8 Bit Volatile	Update Rate	Module reset, Modbus interface reset or Modbus interface enable
Display Format	None	Decimal Places	0
Coding	RO, TE, ND, BU		

Safety information
Introduction
Mechanical installation
Electrical installation
Getting started
Parameters
Key features and Protocols
PC Applications
Security
Diagnostics
Glossary of terms
Index

Value	Text	Description
0	No error	No error
1	Port in use	Specified port is currently in use by another protocol
2	Timeout event	Timeout trigger event location is not valid
3	Num Connections	The Max priority connection is greater than the max connections

This parameter will indicate any Modbus configuration errors.

S.15.005		Modbus Listening Port	
Minimum	0	Maximum	65535
Default	502	Units	
Type	16 Bit User Save	Update Rate	MODBUS_THREAD_TICK_TIME
Display Format	None	Decimal Places	0
Coding	RW, BU		

This parameter can be changed from its default port of 502, however it is the user's responsibility to ensure that a valid port is set.

S.15.006		Maximum Connections	
Minimum	0	Maximum	4
Default	2	Units	
Type	8 Bit User Save	Update Rate	Module reset, Modbus interface reset or Modbus interface enable
Display Format	None	Decimal Places	0
Coding	RW, BU		

This parameter permits the user to specify the total number of connections that one or more clients can open with the module at any one time.

S.15.007		Maximum Priority Connections	
Minimum	0	Maximum	4
Default	2	Units	
Type	8 Bit User Save	Update Rate	Module reset, Modbus interface reset or Modbus interface enable
Display Format	None	Decimal Places	0
Coding	RW, BU		

This parameter defines how many of the maximum connections specified in *Maximum Connections* (**S.15.006**) can be configured as a priority connection. A connection is accepted into the priority connections pool if the client's IP address matches one of the values stored in parameters *Priority Connection 1* (**S.15.020**), *Priority Connection 2* (**S.15.021**), *Priority Connection 3* (**S.15.022**) or *Priority Connection 4* (**S.15.023**).

The priority connections are permanent and, once made will only be deleted at the request of the client or due to a communications error.

Any connections not in the priority connections pool are kept in the non-priority connections pool. If a client attempts to establish a priority connection and all available non-priority connections are in use, the non-priority connection that has not been used for the longest will be closed to make way for the new priority connection.

S.15.008 Maximum Priority Connections Per Client			
Minimum	1	Maximum	4
Default	2	Units	
Type	8 Bit User Save	Update Rate	Module reset, Modbus interface reset or Modbus interface enable
Display Format	None	Decimal Places	0
Coding	RW, BU		

This parameter defines the maximum number of priority connections that any one client can establish. This check is only performed on the connections in the priority connections pool.

S.15.009 Modbus Timeout			
Minimum	1	Maximum	10000
Default	100	Units	ms
Type	16 Bit User Save	Update Rate	Module reset, Modbus interface reset or Modbus interface enable
Display Format	None	Decimal Places	0
Coding	RW, BU		

This parameter defines the time period in which the Modbus server must receive a message before any specified action (as defined in *Modbus Timeout Action (S.15.010)*) is performed. When the timeout occurs, bit 2 in the module's alarm parameter (*Active Alarm Bits (S.00.009)*) will be set and the specified action will be performed.

The timeout is enabled when the server receives its first message.

NOTE It is good system design to allow for some message loss by setting the timeout duration to be greater than the transmit period by a factor of 2 or more.

S.15.010 Modbus Timeout Action			
Minimum	0	Maximum	1
Default	1	Units	
Type	8 Bit User Save	Update Rate	Module reset, Modbus interface reset or Modbus interface enable
Display Format	None	Decimal Places	0
Coding	RW, TE, BU		

Safety information
Introduction
Mechanical installation
Electrical installation
Getting started
Parameters
Key features and protocols
PC Applications
Security
Diagnostics
Glossary of terms
Index

Value	Text	Description
0	Trip	Trip drive and raise error
1	No action	No action

Defines the action when no message is received within the time period specified in *Modbus Timeout (S.15.009)*.

S.15.011		Modbus Timeout Event Destination	
Minimum	0	Maximum	4
Default	0	Units	
Type	8 Bit User Save	Update Rate	Module reset, Modbus interface reset or Modbus interface enable
Display Format	None	Decimal Places	0
Coding	RW, TE, BU		

Value	Text	Description
0	This slot	Trigger event in this slot
1	Slot 1	Trigger event in slot 1
2	Slot 2	Trigger event in slot 2
3	Slot 3	Trigger event in slot 3
4	Slot 4	Trigger event in slot 4

Defines the destination slot to trigger the event (defined by *Modbus Timeout Event Type (S.15.012)*) when a timeout occurs.

NOTE This feature is not yet implemented.

S.15.012		Modbus Timeout Event Type	
Minimum	0	Maximum	5
Default	0	Units	
Type	8 Bit User Save	Update Rate	Module reset, Modbus interface reset or Modbus interface enable
Display Format	None	Decimal Places	0
Coding	RW, TE, BU		

Value	Text	Description
0	No event	No event
1	Trigger Event	Trigger module Event
2	Trigger Event 1	Trigger module Event 1
3	Trigger Event 2	Trigger module Event 2
4	Trigger Event 3	Trigger module Event 3
5	Trigger Event 4	Trigger module Event 4

Defines the event to trigger when a timeout occurs. *Modbus Timeout Event Destination* (S.15.011) must specify an appropriate consumer (slot option) of the event.

NOTE This feature is not yet implemented.

S.15.013 Modbus Register Addressing Mode			
Minimum	0	Maximum	1
Default	0	Units	
Type	8 Bit User Save	Update Rate	Module reset, Modbus interface reset or Modbus interface enable
Display Format	None	Decimal Places	0
Coding	RW, TE, BU		

Value	Text	Description
0	Standard	(mm x 100) + ppp - mm<=162 and ppp<=99
1	Modified	(mm x 256) + ppp - mm<=63 and ppp<=255

Specifies the Modbus register addressing mode.

S.15.020 Priority Connection 1			
Minimum	0 (Display: 0.0.0.0)	Maximum	4294967295 (Display: 255.255.255.255)
Default	0 (Display: 0.0.0.0)	Units	
Type	32 Bit User Save	Update Rate	Module reset, Modbus interface reset or Modbus interface enable
Display Format	IP Address	Decimal Places	0
Coding	RW, BU		

This parameter specifies an IP address for a priority connection.

S.15.021		Priority Connection 2	
Minimum	0 (Display: 0.0.0.0)	Maximum	4294967295 (Display: 255.255.255.255)
Default	0 (Display: 0.0.0.0)	Units	
Type	32 Bit User Save	Update Rate	Module reset, Modbus interface reset or Modbus interface enable
Display Format	IP Address	Decimal Places	0
Coding	RW, BU		

This parameter specifies an IP address for a priority connection.

S.15.022		Priority Connection 3	
Minimum	0 (Display: 0.0.0.0)	Maximum	4294967295 (Display: 255.255.255.255)
Default	0 (Display: 0.0.0.0)	Units	
Type	32 Bit User Save	Update Rate	Module reset, Modbus interface reset or Modbus interface enable
Display Format	IP Address	Decimal Places	0
Coding	RW, BU		

This parameter specifies an IP address for a priority connection.

S.15.023		Priority Connection 4	
Minimum	0 (Display: 0.0.0.0)	Maximum	4294967295 (Display: 255.255.255.255)
Default	0 (Display: 0.0.0.0)	Units	
Type	32 Bit User Save	Update Rate	Module reset, Modbus interface reset or Modbus interface enable
Display Format	IP Address	Decimal Places	0
Coding	RW, BU		

This parameter specifies an IP address for a priority connection.

6.1.7 Menu 20 – EtherNet/IP Set-up

The Ethernet interface supports the EtherNet/IP protocol and conforms to the EtherNet/IP adaptation of the Common Industrial Protocol (CIP) Specification. This is the same upper-layer protocol and object model as used in DeviceNet.

The Ethernet interface will operate as a slave device and the following functionality is supported.

- Variable length input assembly object (instance 100) with consistency for up to 20 parameters

- Variable length output assembly object (instance 101) with consistency for up to 20 parameters
- User selectable RPI timeout action
- Identity object (class 0x01)
- Motor data object (class 0x28)
- Control supervisor object (class 0x29)
- AC/DC Drive object (class 0x2A)
- Control Techniques objects (classes 0x64 to 0x69)
- Explicit (non-cyclic) access to parameters

EtherNet/IP server port

The Ethernet interface uses the standard server port 44818 (0xAF12) for EtherNet/IP communications, this is fixed and cannot be changed.

Parameter Update Rate

Parameters are exchanged over the network. The value exchanged over the network must be exchanged with the drive or option parameter. The rate of data exchange differs for drive and option destinations.

The diagram below depicts the update cycles used within the Ethernet interface. CIP assembly mappings being exchanged with the drive will be updated at the background task rate. This rate (*Background cycles per second (S.09.008)*) varies with the load on the Ethernet interface; Easy Mode non-synchronized data exchange also takes place in the background task.

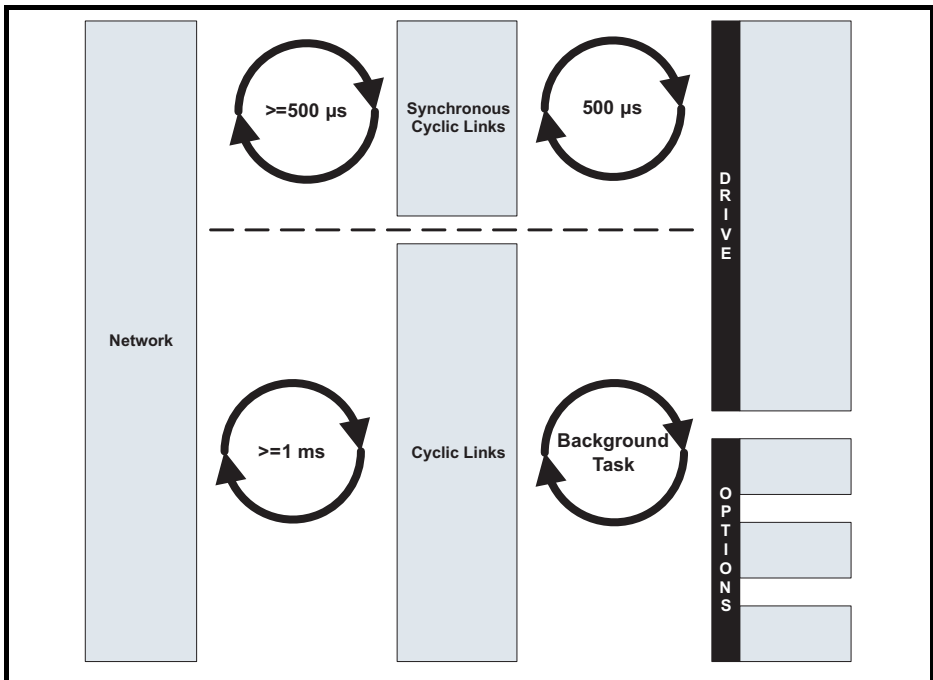

Safety information
Introduction
Mechanical installation
Electrical installation
Getting started
Parameters
Key features and Protocols
PC Applications
Security
Diagnostics
Glossary of terms
Index

S.20.001		Enable EtherNet/IP	
Minimum	0	Maximum	1
Default	1	Units	
Type	1 Bit User Save	Update Rate	Background read
Display Format	None	Decimal Places	0
Coding	RW, BU		

This parameter is used to enable or disable EtherNet/IP slave functionality.

NOTE If either *Input Assembly Object Size (S.20.020)* or *Output Assembly Object Size (S.20.021)* is a non zero value then the available mappings will still be consumed even if the Ethernet/IP functionality is disabled.

S.20.002		Reset	
Minimum	0	Maximum	1
Default	0	Units	
Type	1 Bit Volatile	Update Rate	Background read; written to 0 on initialization
Display Format		Decimal Places	0
Coding	RW, NC		

This parameter is used to perform a warm reset of the protocol interface. When set and the protocol has reset, the parameter will be reset to zero (Off).

S.20.003		Default	
Minimum	0	Maximum	1
Default	0	Units	
Type	1 Bit Volatile	Update Rate	On module reset, protocol interface reset or protocol enable
Display Format	None	Decimal Places	0
Coding	RW, NC		

This parameter allows the protocol to be defaulted to factory settings. This includes all of the protocol features, configuration, mappings and stored objects.

S.20.004		Configuration error	
Minimum	0	Maximum	8
Default		Units	
Type	8 Bit Volatile	Update Rate	Background
Display Format	None	Decimal Places	0
Coding	RO, TE, ND, NC, PT, BU		

Value	Text	Description
0	No error	No error
1	RPI event dst	RPI timeout event destination not valid
2	RPI event type	RPI timeout event type not valid
3	IDLE event dst	PLC IDLE event destination not valid
4	IDLE event type	PLC IDLE event type not valid
5	Input mapping	Input mapping parameter not valid
6	Output mapping	Output mapping parameter not valid
7	In cons trig pr	Input consistency trigger parameter not valid
8	Out cons trig pr	Output consistency trigger parameter not valid

This parameter is used to display the error code if an EtherNet/IP configuration error occurs.

S.20.007		Cyclic data transfers per second	
Minimum	0	Maximum	65535
Default		Units	Messages/s
Type	16 Bit Volatile	Update Rate	Background
Display Format	None	Decimal Places	0
Coding	RO, ND, NC, PT, BU		

This parameter shows the EtherNet/IP cyclic data transfer rate.

S.20.011		RPI timeout action	
Minimum	0	Maximum	4
Default	3	Units	
Type	8 Bit User Save	Update Rate	Module reset, EtherNet/IP interface reset or EtherNet/IP interface enable
Display Format	None	Decimal Places	0
Coding	RW, TE, BU		

Value	Text	Description
0	Trip	Trip drive with Slx.Er and sub-trip code
1	Send fit values	Send configured fault values to the output parameters
2	Clear output	PLC output parameters will have their values set to zero
3	Hold last	Hold the last value in output parameters
4	No Action	No action with output parameters

This timeout is defined by the EtherNet/IP protocol and is configured in the PLC master. The interface will monitor the data traffic and if data is not received within the specified time, it will perform the requested action. This indicates that the interface has detected

that the cyclic data communication has been interrupted.

Trip

On an RPI timeout the interface will cause a slot trip with sub trip value 101 (EtherNet/IP RPI Timeout).

Send Fault Values

On an RPI timeout the interface will not trip the drive. It will write the values specified in Fault Values menu (23) to the PLC output mappings for the assembly object 101 if active.

Clear Output

On an RPI timeout the interface will not trip the drive. It will write all PLC output mappings for the assembly object 101 if active to zero.

Hold Last

On an RPI timeout the interface will not trip the drive. The last value received will be maintained.

No Action

On an RPI timeout the interface will not trip the drive. The last value received will be maintained.

S.20.012		RPI timeout event destination	
Minimum	0	Maximum	4
Default	0	Units	
Type	8 Bit User Save	Update Rate	Module reset, EtherNet/IP interface reset or EtherNet/IP interface enable
Display Format	None	Decimal Places	0
Coding	RW, TE, BU		

Value	Text	Description
0	This slot	Trigger event in this slot
1	Slot 1	Trigger event in slot 1
2	Slot 2	Trigger event in slot 2
3	Slot 3	Trigger event in slot 3
4	Slot 4	Trigger event in slot 4

This parameter defines the destination slot to trigger the event upon an RPI timeout.

NOTE This feature is not yet implemented.

S.20.013		RPI timeout event type	
Minimum	0	Maximum	5
Default	0	Units	
Type	8 Bit User Save	Update Rate	Module reset, EtherNet/IP interface reset or EtherNet/IP interface enable
Display Format	None	Decimal Places	0
Coding	RW, TE, BU		

Value	Text	Description
0	No event	No event
1	Trigger Event	Trigger module Event
2	Trigger Event 1	Trigger module Event 1
3	Trigger Event 2	Trigger module Event 2
4	Trigger Event 3	Trigger module Event 3
5	Trigger Event 4	Trigger module Event 4

Defines the event to trigger in the specified destination (*RPI timeout event destination* (**S.20.012**)) upon an RPI timeout.

NOTE This feature is not yet implemented.

S.20.015		PLC idle action	
Minimum	0	Maximum	4
Default	4	Units	
Type	8 Bit User Save	Update Rate	Module reset, EtherNet/IP interface reset or EtherNet/IP interface enable
Display Format	None	Decimal Places	0
Coding	RW, TE, BU		

Value	Text	Description
0	Trip	Trip drive with Slx.Er and sub-trip code
1	Send fit values	Send configured fault values to the output parameters
2	Clear output	PLC output parameters will have their values set to zero
3	Hold last	Hold the last value in output parameters
4	No Action	No action with output parameters

This parameter defines the action to be taken upon a PLC idle event.

S.20.016		PLC idle event destination	
Minimum	0	Maximum	4
Default	0	Units	
Type	8 Bit User Save	Update Rate	Module reset, EtherNet/IP interface reset or EtherNet/IP interface enable
Display Format	None	Decimal Places	0
Coding	RW, TE, BU		

Value	Text	Description
0	This slot	Trigger event in this slot
1	Slot 1	Trigger event in slot 1
2	Slot 2	Trigger event in slot 2
3	Slot 3	Trigger event in slot 3
4	Slot 4	Trigger event in slot 4

This parameter defines the destination slot to trigger the event upon a PLC idle event.

NOTE This feature is not yet implemented.

S.20.017		PLC idle event type	
Minimum	0	Maximum	5
Default	0	Units	
Type	8 Bit User Save	Update Rate	Module reset, EtherNet/IP interface reset or EtherNet/IP interface enable
Display Format	None	Decimal Places	0
Coding	RW, TE, BU		

Value	Text	Description
0	No event	No event
1	Trigger Event	Trigger module Event
2	Trigger Event 1	Trigger module Event 1
3	Trigger Event 2	Trigger module Event 2
4	Trigger Event 3	Trigger module Event 3
5	Trigger Event 4	Trigger module Event 4

Defines the event to trigger in the specified destination (*PLC idle event destination* (**S.20.016**)) upon a PLC idle event.

NOTE This feature is not yet implemented.

S.20.018		Active input assembly object	
Minimum	0	Maximum	4
Default	0	Units	
Type	8 Bit Volatile	Update Rate	Module reset, EtherNet/IP interface reset or EtherNet/IP interface enable
Display Format	None	Decimal Places	0
Coding	RO, TE, NC, PT, BU		

Value	Text	Description	
0	100-PrimaryI	Primary input (100)	
1	70-BscSpdCtrlI	Basic speed control input (70)	
2	71-ExtSpdCtrlI	Extended speed control input (71)	
3	72-SpdTqCtrlI	Speed and torque control input (72)	
4	73-ExtSpdTqCtrlI	Extended speed and torque control input (73)	

This parameter defines and shows the required input assembly object.

S.20.019		Active output assembly object	
Minimum	0	Maximum	4
Default	0	Units	
Type	8 Bit Volatile	Update Rate	Module reset, EtherNet/IP interface reset or EtherNet/IP interface enable
Display Format	None	Decimal Places	0
Coding	RO, TE, NC, PT, BU		

Value	Text	Description	
0	101-PrimaryO	Primary output (101)	
1	20-BscSpdCtrlO	Basic speed control output (20)	
2	21-ExtSpdCtrlO	Extended speed control output (21)	
3	22-SpdTqCtrlO	Speed and torque control output (22)	
4	23-ExtSpdTqCtrlO	Extended speed and torque control output (23)	

This parameter defines and shows the required output assembly object.

S.20.020		Input assembly object size	
Minimum	4	Maximum	80
Default	8	Units	Bytes
Type	8 Bit User Save	Update Rate	Module reset, EtherNet/IP interface reset or EtherNet/IP interface enable
Display Format	None	Decimal Places	0
Coding	RW, BU		

This parameter defines the size of the input assembly object (100).

S.20.021		Output assembly object size	
Minimum	4	Maximum	80
Default	8	Units	Bytes
Type	8 Bit User Save	Update Rate	Module reset, EtherNet/IP interface reset or EtherNet/IP interface enable
Display Format	None	Decimal Places	0
Coding	RW, BU		

This parameter defines the size of the output assembly object (101).

S.20.024		Input assembly object process time	
Minimum	0	Maximum	65535
Default		Units	ms
Type	16 Bit Volatile	Update Rate	Background
Display Format	None	Decimal Places	0
Coding	RO, ND, NC, PT, BU		

This is the time between getting the input value from the master and it being sent successfully to the drive.

S.20.025		Output assembly object process time	
Minimum	0	Maximum	65535
Default		Units	ms
Type	16 Bit Volatile	Update Rate	Background
Display Format	None	Decimal Places	0
Coding	RO, ND, NC, PT, BU		

This is the time between getting the output value from the drive and it being sent successfully to the master.

S.20.026		Input assembly object consistency enable	
Minimum	0	Maximum	1
Default	0	Units	
Type	1 Bit User Save	Update Rate	Module reset, EtherNet/IP interface reset or EtherNet/IP interface enable
Display Format	None	Decimal Places	0
Coding	RW		

This parameter allows for enabling and disabling input assembly object consistency.

Under normal conditions, cyclic data is sampled and transmitted at the Requested Packet Interval (RPI). However, if an option module was in the process of modifying the mapped parameters while these parameters were being sampled, then the data transmitted across the network may not be consistent across the entire assembly object. If read consistency is enabled (and a trigger parameter specified in *Input assembly object consistency trigger parameter (S.20.027)*) then data will only be sampled and transmitted to the PLC or EtherNet/IP master when the trigger parameter *Input assembly object consistency trigger parameter (S.20.027)* contains a non-zero value. This trigger parameter will then be set to zero after the data has been transmitted.

It is therefore possible, by controlling the trigger parameters, that a user program in the drive or option module can ensure that the values in the cyclic data parameters are not sampled until all values are updated.

Whether consistency is enabled or not, data will always be consistent for an individual parameter, i.e. all 4 bytes of a 32 bit value will be consistent.

NOTE If read consistency is enabled, then at reset or at power-up, the value in the trigger parameter is set to zero.

S.20.027		Input assembly object consistency trigger parameter	
Minimum	0 (Display: 0.00.000)	Maximum	499999 (Display: 4.99.999)
Default	0 (Display: 0.00.000)	Units	
Type	32 Bit User Save	Update Rate	Module reset, EtherNet/IP interface reset or EtherNet/IP interface enable
Display Format	Slot Menu Param	Decimal Places	0
Coding	RW, BU		

This parameter specifies the parameter to use for triggering input assembly object consistency. See *Input assembly object consistency enable (S.20.026)* for more information on consistency.

S.20.028		Output assembly object consistency enable	
Minimum	0	Maximum	1
Default	0	Units	
Type	1 Bit User Save	Update Rate	Module reset, EtherNet/IP interface reset or EtherNet/IP interface enable
Display Format	None	Decimal Places	0
Coding	RW		

This parameter allows for enabling and disabling output assembly object consistency.

Writing of data can be controlled using consistency by enabling this parameter and setting a trigger parameter (*Output assembly object consistency trigger parameter (S.20.029)*).

Consistency enabled

When the output consistency is enabled, the value in *Output assembly object consistency trigger parameter (S.20.029)* is checked at the beginning of the writing routine. If it is zero then the PLC or EtherNet/IP master output values are written to the cyclic data destination parameters and the trigger parameter is set to one. If the output trigger parameter value is non-zero then the output values are not written to the destination parameters.

NOTE If write consistency is enabled, then at reset or at power-up, the value in the trigger parameter is set to one.

Consistency disabled

When the output consistency is disabled, the output values are written to the cyclic data destination parameters at the background task rate after it has been received.

S.20.029		Output assembly object consistency trigger parameter	
Minimum	0 (Display: 0.00.000)	Maximum	499999 (Display: 4.99.999)
Default	0 (Display: 0.00.000)	Units	
Type	32 Bit User Save	Update Rate	Module reset, EtherNet/IP interface reset or EtherNet/IP interface enable
Display Format	Slot Menu Param	Decimal Places	0
Coding	RW, BU		

This parameter specifies the parameter to use for triggering output assembly object consistency. See *Output assembly object consistency enable (S.20.028)* for more information on consistency.

S.20.030		Custom Vendor ID	
Minimum	0	Maximum	1
Default	0	Units	
Type	8 Bit User Save	Update Rate	Module reset, EtherNet/IP interface reset or EtherNet/IP interface enable
Display Format	None	Decimal Places	0
Coding	RW, TE, BU		

Value	Text	Description
0	257 - CT	EtherNet/IP interface
1	553 - CT AMERICA	EtherNet/IP America interface

This parameter defines the customised vendor ID.

S.20.031		Custom product code	
Minimum	0	Maximum	65535
Default	0	Units	
Type	16 Bit User Save	Update Rate	Module reset, EtherNet/IP interface reset or EtherNet/IP interface enable
Display Format	None	Decimal Places	0
Coding	RW, BU		

This parameter defines a custom product type value which is used to identify the product on the network.

S.20.032		Custom product revision code	
Minimum	0	Maximum	65535
Default	0	Units	
Type	16 Bit User Save	Update Rate	Module reset, EtherNet/IP interface reset or EtherNet/IP interface enable
Display Format	None	Decimal Places	0
Coding	RW, BU		

This parameter defines a custom product revision value which is used to identify the product on the network.

Safety information
Introduction
Mechanical installation
Electrical installation
Getting started
Parameters
Key features and Protocols
PC Applications
Security
Diagnostics
Glossary of terms
Index

S.20.033		Actual product code	
Minimum	0	Maximum	65535
Default	0	Units	
Type	16 Bit Volatile	Update Rate	Module reset, EtherNet/IP interface reset or EtherNet/IP interface enable
Display Format	None	Decimal Places	0
Coding	RO, NC, PT, BU		

This parameter defines the actual product code.

S.20.034		Actual product revision	
Minimum	0	Maximum	65535
Default	0	Units	
Type	16 Bit Volatile	Update Rate	Module reset, EtherNet/IP interface reset or EtherNet/IP interface enable
Display Format	None	Decimal Places	0
Coding	RO, NC, PT, BU		

This parameter defines the actual revision number.

S.20.040		Type of motor 1	
Minimum	0	Maximum	4
Default	2	Units	
Type	8 Bit User Save	Update Rate	Reset
Display Format	None	Decimal Places	0
Coding	RO, TE, PT, BU		

Value	Text	Description
0	2-FC DC	FC DC Motor
1	6-WRI	Wound Rotor Induction Motor
2	7-SCI	Squirrel Cage Induction Motor
3	9-Sin PM BL	Sinusoidal PM BL Motor
4	10-Trape PM BL	Trapezoidal PM BL Motor

This parameter defines the type of motor 1.

S.20.041		Type of motor 2	
Minimum	0	Maximum	4
Default	2	Units	
Type	8 Bit User Save	Update Rate	Reset
Display Format	None	Decimal Places	0
Coding	RO, TE, PT, BU		

Value	Text	Description	
0	2-FC DC	FC DC Motor	
1	6-WRI	Wound Rotor Induction Motor	
2	7-SCI	Squirrel Cage Induction Motor	
3	9-Sin PM BL	Sinusoidal PM BL Motor	
4	10-Trap PM BL	Trapezoidal PM BL Motor	

This parameter defines the type of motor 2.

6.1.8 Menu 21 – EtherNet/IP In Mappings

This menu contains the parameters used to define the source parameters for data that will be transmitted to the PLC.

S.21.001		Input mapping parameter 1	
Minimum	0 (Display: 0.00.000)	Maximum	499999 (Display: 4.99.999)
Default	10040 (Display: 0.10.040)	Units	
Type	32 Bit User Save	Update Rate	Module reset, EtherNet/IP interface reset or EtherNet/IP interface enable
Display Format	Slot Menu Param	Decimal Places	0
Coding	RW, DE, PT, BU		

S.21.002		Input mapping parameter 2	
Minimum	0 (Display: 0.00.000)	Maximum	499999 (Display: 4.99.999)
Default	2001 (Display: 0.02.001)	Units	
Type	32 Bit User Save	Update Rate	Module reset, EtherNet/IP interface reset or EtherNet/IP interface enable
Display Format	Slot Menu Param	Decimal Places	0
Coding	RW, DE, PT, BU		

S.21.003		Input mapping parameter 3	
Minimum	0 (Display: 0.00.000)	Maximum	499999 (Display: 4.99.999)
Default	0 (Display: 0.00.000)	Units	
Type	32 Bit User Save	Update Rate	Module reset, EtherNet/IP interface reset or EtherNet/IP interface enable
Display Format	Slot Menu Param	Decimal Places	0
Coding	RW, DE, PT, BU		

S.21.004		Input mapping parameter 4	
Minimum	0 (Display: 0.00.000)	Maximum	499999 (Display: 4.99.999)
Default	0 (Display: 0.00.000)	Units	
Type	32 Bit User Save	Update Rate	Module reset, EtherNet/IP interface reset or EtherNet/IP interface enable
Display Format	Slot Menu Param	Decimal Places	0
Coding	RW, DE, PT, BU		

S.21.005		Input mapping parameter 5	
Minimum	0 (Display: 0.00.000)	Maximum	499999 (Display: 4.99.999)
Default	0 (Display: 0.00.000)	Units	
Type	32 Bit User Save	Update Rate	Module reset, EtherNet/IP interface reset or EtherNet/IP interface enable
Display Format	Slot Menu Param	Decimal Places	0
Coding	RW, DE, PT, BU		

S.21.006		Input mapping parameter 6	
Minimum	0 (Display: 0.00.000)	Maximum	499999 (Display: 4.99.999)
Default	0 (Display: 0.00.000)	Units	
Type	32 Bit User Save	Update Rate	Module reset, EtherNet/IP interface reset or EtherNet/IP interface enable
Display Format	Slot Menu Param	Decimal Places	0
Coding	RW, DE, PT, BU		

S.21.007		Input mapping parameter 7	
Minimum	0 (Display: 0.00.000)	Maximum	499999 (Display: 4.99.999)
Default	0 (Display: 0.00.000)	Units	
Type	32 Bit User Save	Update Rate	Module reset, EtherNet/IP interface reset or EtherNet/IP interface enable
Display Format	Slot Menu Param	Decimal Places	0
Coding	RW, DE, PT, BU		

S.21.008		Input mapping parameter 8	
Minimum	0 (Display: 0.00.000)	Maximum	499999 (Display: 4.99.999)
Default	0 (Display: 0.00.000)	Units	
Type	32 Bit User Save	Update Rate	Module reset, EtherNet/IP interface reset or EtherNet/IP interface enable
Display Format	Slot Menu Param	Decimal Places	0
Coding	RW, DE, PT, BU		

S.21.009		Input mapping parameter 9	
Minimum	0 (Display: 0.00.000)	Maximum	499999 (Display: 4.99.999)
Default	0 (Display: 0.00.000)	Units	
Type	32 Bit User Save	Update Rate	Module reset, EtherNet/IP interface reset or EtherNet/IP interface enable
Display Format	Slot Menu Param	Decimal Places	0
Coding	RW, DE, PT, BU		

S.21.010		Input mapping parameter 10	
Minimum	0 (Display: 0.00.000)	Maximum	499999 (Display: 4.99.999)
Default	0 (Display: 0.00.000)	Units	
Type	32 Bit User Save	Update Rate	Module reset, EtherNet/IP interface reset or EtherNet/IP interface enable
Display Format	Slot Menu Param	Decimal Places	0
Coding	RW, DE, PT, BU		

Safety information
Introduction
Mechanical installation
Electrical installation
Getting started
Parameters
Key features and Protocols
PC Applications
Security
Diagnostics
Glossary of terms
Index

S.21.011		Input mapping parameter 11	
Minimum	0 (Display: 0.00.000)	Maximum	499999 (Display: 4.99.999)
Default	0 (Display: 0.00.000)	Units	
Type	32 Bit User Save	Update Rate	Module reset, EtherNet/IP interface reset or EtherNet/IP interface enable
Display Format	Slot Menu Param	Decimal Places	0
Coding	RW, DE, PT, BU		

S.21.012		Input mapping parameter 12	
Minimum	0 (Display: 0.00.000)	Maximum	499999 (Display: 4.99.999)
Default	0 (Display: 0.00.000)	Units	
Type	32 Bit User Save	Update Rate	Module reset, EtherNet/IP interface reset or EtherNet/IP interface enable
Display Format	Slot Menu Param	Decimal Places	0
Coding	RW, DE, PT, BU		

S.21.013		Input mapping parameter 13	
Minimum	0 (Display: 0.00.000)	Maximum	499999 (Display: 4.99.999)
Default	0 (Display: 0.00.000)	Units	
Type	32 Bit User Save	Update Rate	Module reset, EtherNet/IP interface reset or EtherNet/IP interface enable
Display Format	Slot Menu Param	Decimal Places	0
Coding	RW, DE, PT, BU		

S.21.014		Input mapping parameter 14	
Minimum	0 (Display: 0.00.000)	Maximum	499999 (Display: 4.99.999)
Default	0 (Display: 0.00.000)	Units	
Type	32 Bit User Save	Update Rate	Module reset, EtherNet/IP interface reset or EtherNet/IP interface enable
Display Format	Slot Menu Param	Decimal Places	0
Coding	RW, DE, PT, BU		

S.21.015		Input mapping parameter 15	
Minimum	0 (Display: 0.00.000)	Maximum	499999 (Display: 4.99.999)
Default	0 (Display: 0.00.000)	Units	
Type	32 Bit User Save	Update Rate	Module reset, EtherNet/IP interface reset or EtherNet/IP interface enable
Display Format	Slot Menu Param	Decimal Places	0
Coding	RW, DE, PT, BU		

S.21.016		Input mapping parameter 16	
Minimum	0 (Display: 0.00.000)	Maximum	499999 (Display: 4.99.999)
Default	0 (Display: 0.00.000)	Units	
Type	32 Bit User Save	Update Rate	Module reset, EtherNet/IP interface reset or EtherNet/IP interface enable
Display Format	Slot Menu Param	Decimal Places	0
Coding	RW, DE, PT, BU		

S.21.017		Input mapping parameter 17	
Minimum	0 (Display: 0.00.000)	Maximum	499999 (Display: 4.99.999)
Default	0 (Display: 0.00.000)	Units	
Type	32 Bit User Save	Update Rate	Module reset, EtherNet/IP interface reset or EtherNet/IP interface enable
Display Format	Slot Menu Param	Decimal Places	0
Coding	RW, DE, PT, BU		

S.21.018		Input mapping parameter 18	
Minimum	0 (Display: 0.00.000)	Maximum	499999 (Display: 4.99.999)
Default	0 (Display: 0.00.000)	Units	
Type	32 Bit User Save	Update Rate	Module reset, EtherNet/IP interface reset or EtherNet/IP interface enable
Display Format	Slot Menu Param	Decimal Places	0
Coding	RW, DE, PT, BU		

Safety information
Introduction
Mechanical installation
Electrical installation
Getting started
Parameters
Key features and Protocols
PC Applications
Security
Diagnostics
Glossary of terms
Index

S.21.019		Input mapping parameter 19	
Minimum	0 (Display: 0.00.000)	Maximum	499999 (Display: 4.99.999)
Default	0 (Display: 0.00.000)	Units	
Type	32 Bit User Save	Update Rate	Module reset, EtherNet/IP interface reset or EtherNet/IP interface enable
Display Format	Slot Menu Param	Decimal Places	0
Coding	RW, DE, PT, BU		

S.21.020		Input mapping parameter 20	
Minimum	0 (Display: 0.00.000)	Maximum	499999 (Display: 4.99.999)
Default	0 (Display: 0.00.000)	Units	
Type	32 Bit User Save	Update Rate	Module reset, EtherNet/IP interface reset or EtherNet/IP interface enable
Display Format	Slot Menu Param	Decimal Places	0
Coding	RW, DE, PT, BU		

6.1.9 Menu 22 – EtherNet/IP Out Mappings

This menu contains the parameters used to define the destination parameters for data that will be transmitted from the PLC.

S.22.001		Output mapping parameter 1	
Minimum	0 (Display: 0.00.000)	Maximum	499999 (Display: 4.99.999)
Default	6042 (Display: 0.06.042)	Units	
Type	32 Bit User Save	Update Rate	Module reset, EtherNet/IP interface reset or EtherNet/IP interface enable
Display Format	Slot Menu Param	Decimal Places	0
Coding	RW, DE, PT, BU		

S.22.002		Output mapping parameter 2	
Minimum	0 (Display: 0.00.000)	Maximum	499999 (Display: 4.99.999)
Default	1021 (Display: 0.01.021)	Units	
Type	32 Bit User Save	Update Rate	Module reset, EtherNet/IP interface reset or EtherNet/IP interface enable
Display Format	Slot Menu Param	Decimal Places	0
Coding	RW, DE, PT, BU		

S.22.003		Output mapping parameter 3	
Minimum	0 (Display: 0.00.000)	Maximum	499999 (Display: 4.99.999)
Default	0 (Display: 0.00.000)	Units	
Type	32 Bit User Save	Update Rate	Module reset, EtherNet/IP interface reset or EtherNet/IP interface enable
Display Format	Slot Menu Param	Decimal Places	0
Coding	RW, DE, PT, BU		

S.22.004		Output mapping parameter 4	
Minimum	0 (Display: 0.00.000)	Maximum	499999 (Display: 4.99.999)
Default	0 (Display: 0.00.000)	Units	
Type	32 Bit User Save	Update Rate	Module reset, EtherNet/IP interface reset or EtherNet/IP interface enable
Display Format	Slot Menu Param	Decimal Places	0
Coding	RW, DE, PT, BU		

S.22.005		Output mapping parameter 5	
Minimum	0 (Display: 0.00.000)	Maximum	499999 (Display: 4.99.999)
Default	0 (Display: 0.00.000)	Units	
Type	32 Bit User Save	Update Rate	Module reset, EtherNet/IP interface reset or EtherNet/IP interface enable
Display Format	Slot Menu Param	Decimal Places	0
Coding	RW, DE, PT, BU		

Safety information
Introduction
Mechanical installation
Electrical installation
Getting started
Parameters
Key features and Protocols
PC Applications
Security
Diagnostics
Glossary of terms
Index

S.22.006		Output mapping parameter 6	
Minimum	0 (Display: 0.00.000)	Maximum	499999 (Display: 4.99.999)
Default	0 (Display: 0.00.000)	Units	
Type	32 Bit User Save	Update Rate	Module reset, EtherNet/IP interface reset or EtherNet/IP interface enable
Display Format	Slot Menu Param	Decimal Places	0
Coding	RW, DE, PT, BU		

S.22.007		Output mapping parameter 7	
Minimum	0 (Display: 0.00.000)	Maximum	499999 (Display: 4.99.999)
Default	0 (Display: 0.00.000)	Units	
Type	32 Bit User Save	Update Rate	Module reset, EtherNet/IP interface reset or EtherNet/IP interface enable
Display Format	Slot Menu Param	Decimal Places	0
Coding	RW, DE, PT, BU		

S.22.008		Output mapping parameter 8	
Minimum	0 (Display: 0.00.000)	Maximum	499999 (Display: 4.99.999)
Default	0 (Display: 0.00.000)	Units	
Type	32 Bit User Save	Update Rate	Module reset, EtherNet/IP interface reset or EtherNet/IP interface enable
Display Format	Slot Menu Param	Decimal Places	0
Coding	RW, DE, PT, BU		

S.22.009		Output mapping parameter 9	
Minimum	0 (Display: 0.00.000)	Maximum	499999 (Display: 4.99.999)
Default	0 (Display: 0.00.000)	Units	
Type	32 Bit User Save	Update Rate	Module reset, EtherNet/IP interface reset or EtherNet/IP interface enable
Display Format	Slot Menu Param	Decimal Places	0
Coding	RW, DE, PT, BU		

S.22.010		Output mapping parameter 10	
Minimum	0 (Display: 0.00.000)	Maximum	499999 (Display: 4.99.999)
Default	0 (Display: 0.00.000)	Units	
Type	32 Bit User Save	Update Rate	Module reset, EtherNet/IP interface reset or EtherNet/IP interface enable
Display Format	Slot Menu Param	Decimal Places	0
Coding	RW, DE, PT, BU		

S.22.011		Output mapping parameter 11	
Minimum	0 (Display: 0.00.000)	Maximum	499999 (Display: 4.99.999)
Default	0 (Display: 0.00.000)	Units	
Type	32 Bit User Save	Update Rate	Module reset, EtherNet/IP interface reset or EtherNet/IP interface enable
Display Format	Slot Menu Param	Decimal Places	0
Coding	RW, DE, PT, BU		

S.22.012		Output mapping parameter 12	
Minimum	0 (Display: 0.00.000)	Maximum	499999 (Display: 4.99.999)
Default	0 (Display: 0.00.000)	Units	
Type	32 Bit User Save	Update Rate	Module reset, EtherNet/IP interface reset or EtherNet/IP interface enable
Display Format	Slot Menu Param	Decimal Places	0
Coding	RW, DE, PT, BU		

S.22.013		Output mapping parameter 13	
Minimum	0 (Display: 0.00.000)	Maximum	499999 (Display: 4.99.999)
Default	0 (Display: 0.00.000)	Units	
Type	32 Bit User Save	Update Rate	Module reset, EtherNet/IP interface reset or EtherNet/IP interface enable
Display Format	Slot Menu Param	Decimal Places	0
Coding	RW, DE, PT, BU		

Safety information
Introduction
Mechanical installation
Electrical installation
Getting started
Parameters
Key features and Protocols
PC Applications
Security
Diagnostics
Glossary of terms
Index

S.22.014		Output mapping parameter 14	
Minimum	0 (Display: 0.00.000)	Maximum	499999 (Display: 4.99.999)
Default	0 (Display: 0.00.000)	Units	
Type	32 Bit User Save	Update Rate	Module reset, EtherNet/IP interface reset or EtherNet/IP interface enable
Display Format	Slot Menu Param	Decimal Places	0
Coding	RW, DE, PT, BU		

S.22.015		Output mapping parameter 15	
Minimum	0 (Display: 0.00.000)	Maximum	499999 (Display: 4.99.999)
Default	0 (Display: 0.00.000)	Units	
Type	32 Bit User Save	Update Rate	Module reset, EtherNet/IP interface reset or EtherNet/IP interface enable
Display Format	Slot Menu Param	Decimal Places	0
Coding	RW, DE, PT, BU		

S.22.016		Output mapping parameter 16	
Minimum	0 (Display: 0.00.000)	Maximum	499999 (Display: 4.99.999)
Default	0 (Display: 0.00.000)	Units	
Type	32 Bit User Save	Update Rate	Module reset, EtherNet/IP interface reset or EtherNet/IP interface enable
Display Format	Slot Menu Param	Decimal Places	0
Coding	RW, DE, PT, BU		

S.22.017		Output mapping parameter 17	
Minimum	0 (Display: 0.00.000)	Maximum	499999 (Display: 4.99.999)
Default	0 (Display: 0.00.000)	Units	
Type	32 Bit User Save	Update Rate	Module reset, EtherNet/IP interface reset or EtherNet/IP interface enable
Display Format	Slot Menu Param	Decimal Places	0
Coding	RW, DE, PT, BU		

S.22.018		Output mapping parameter 18	
Minimum	0 (Display: 0.00.000)	Maximum	499999 (Display: 4.99.999)
Default	0 (Display: 0.00.000)	Units	
Type	32 Bit User Save	Update Rate	Module reset, EtherNet/IP interface reset or EtherNet/IP interface enable
Display Format	Slot Menu Param	Decimal Places	0
Coding	RW, DE, PT, BU		

S.22.019		Output mapping parameter 19	
Minimum	0 (Display: 0.00.000)	Maximum	499999 (Display: 4.99.999)
Default	0 (Display: 0.00.000)	Units	
Type	32 Bit User Save	Update Rate	Module reset, EtherNet/IP interface reset or EtherNet/IP interface enable
Display Format	Slot Menu Param	Decimal Places	0
Coding	RW, DE, PT, BU		

S.22.020		Output mapping parameter 20	
Minimum	0 (Display: 0.00.000)	Maximum	499999 (Display: 4.99.999)
Default	0 (Display: 0.00.000)	Units	
Type	32 Bit User Save	Update Rate	Module reset, EtherNet/IP interface reset or EtherNet/IP interface enable
Display Format	Slot Menu Param	Decimal Places	0
Coding	RW, DE, PT, BU		

Safety information
Introduction
Mechanical installation
Electrical installation
Getting started
Parameters
Key features and Protocols
PC Applications
Security
Diagnostics
Glossary of terms
Index

6.1.10 Menu 23– EtherNet/IP Fault Values

This menu contains the parameters used to define the values to be sent to the mapped output destinations when fault values have been configured to be sent after either a RPI timeout event (see *RPI timeout action* (S.20.011), *RPI timeout event destination* (S.20.012) and *RPI timeout event type* (S.20.013)) or a PLC idle event (see *PLC idle action* (S.20.015), *PLC idle event destination* (S.20.016) and *PLC idle event type* (S.20.017)) has occurred.

S.23.001		Output Fault value 1	
Minimum	-2147483648	Maximum	2147483647
Default	0	Units	
Type	32 Bit User Save	Update Rate	Module reset, EtherNet/IP interface reset or EtherNet/IP interface enable
Display Format	None	Decimal Places	0
Coding	RW, PT		

S.23.002		Output Fault value 2	
Minimum	-2147483648	Maximum	2147483647
Default	0	Units	
Type	32 Bit User Save	Update Rate	Module reset, EtherNet/IP interface reset or EtherNet/IP interface enable
Display Format	None	Decimal Places	0
Coding	RW, PT		

S.23.003		Output Fault value 3	
Minimum	-2147483648	Maximum	2147483647
Default	0	Units	
Type	32 Bit User Save	Update Rate	Module reset, EtherNet/IP interface reset or EtherNet/IP interface enable
Display Format	None	Decimal Places	0
Coding	RW, PT		

S.23.004		Output Fault value 4	
Minimum	-2147483648	Maximum	2147483647
Default	0	Units	
Type	32 Bit User Save	Update Rate	Module reset, EtherNet/IP interface reset or EtherNet/IP interface enable
Display Format	None	Decimal Places	0
Coding	RW, PT		

S.23.005		Output Fault value 5	
Minimum	-2147483648	Maximum	2147483647
Default	0	Units	
Type	32 Bit User Save	Update Rate	Module reset, EtherNet/IP interface reset or EtherNet/IP interface enable
Display Format	None	Decimal Places	0
Coding	RW, PT		

S.23.006		Output Fault value 6	
Minimum	-2147483648	Maximum	2147483647
Default	0	Units	
Type	32 Bit User Save	Update Rate	Module reset, EtherNet/IP interface reset or EtherNet/IP interface enable
Display Format	None	Decimal Places	0
Coding	RW, PT		

S.23.007		Output Fault value 7	
Minimum	-2147483648	Maximum	2147483647
Default	0	Units	
Type	32 Bit User Save	Update Rate	Module reset, EtherNet/IP interface reset or EtherNet/IP interface enable
Display Format	None	Decimal Places	0
Coding	RW, PT		

S.23.008		Output Fault value 8	
Minimum	-2147483648	Maximum	2147483647
Default	0	Units	
Type	32 Bit User Save	Update Rate	Module reset, EtherNet/IP interface reset or EtherNet/IP interface enable
Display Format	None	Decimal Places	0
Coding	RW, PT		

Safety information
Introduction
Mechanical installation
Electrical installation
Getting started
Parameters
Key features and Protocols
PC Applications
Security
Diagnostics
Glossary of terms
Index

S.23.009		Output Fault value 9	
Minimum	-2147483648	Maximum	2147483647
Default	0	Units	
Type	32 Bit User Save	Update Rate	Module reset, EtherNet/IP interface reset or EtherNet/IP interface enable
Display Format	None	Decimal Places	0
Coding	RW, PT		

S.23.010		Output Fault value 10	
Minimum	-2147483648	Maximum	2147483647
Default	0	Units	
Type	32 Bit User Save	Update Rate	Module reset, EtherNet/IP interface reset or EtherNet/IP interface enable
Display Format	None	Decimal Places	0
Coding	RW, PT		

S.23.011		Output Fault value 11	
Minimum	-2147483648	Maximum	2147483647
Default	0	Units	
Type	32 Bit User Save	Update Rate	Module reset, EtherNet/IP interface reset or EtherNet/IP interface enable
Display Format	None	Decimal Places	0
Coding	RW, PT		

S.23.012		Output Fault value 12	
Minimum	-2147483648	Maximum	2147483647
Default	0	Units	
Type	32 Bit User Save	Update Rate	Module reset, EtherNet/IP interface reset or EtherNet/IP interface enable
Display Format	None	Decimal Places	0
Coding	RW, PT		

S.23.013		Output Fault value 13	
Minimum	-2147483648	Maximum	2147483647
Default	0	Units	
Type	32 Bit User Save	Update Rate	Module reset, EtherNet/IP interface reset or EtherNet/IP interface enable
Display Format	None	Decimal Places	0
Coding	RW, PT		

S.23.014		Output Fault value 14	
Minimum	-2147483648	Maximum	2147483647
Default	0	Units	
Type	32 Bit User Save	Update Rate	Module reset, EtherNet/IP interface reset or EtherNet/IP interface enable
Display Format	None	Decimal Places	0
Coding	RW, PT		

S.23.015		Output Fault value 15	
Minimum	-2147483648	Maximum	2147483647
Default	0	Units	
Type	32 Bit User Save	Update Rate	Module reset, EtherNet/IP interface reset or EtherNet/IP interface enable
Display Format	None	Decimal Places	0
Coding	RW, PT		

S.23.016		Output Fault value 16	
Minimum	-2147483648	Maximum	2147483647
Default	0	Units	
Type	32 Bit User Save	Update Rate	Module reset, EtherNet/IP interface reset or EtherNet/IP interface enable
Display Format	None	Decimal Places	0
Coding	RW, PT		

Safety information
Introduction
Mechanical installation
Electrical installation
Getting started
Parameters
Key features and protocols
PC Applications
Security
Diagnostics
Glossary of terms
Index

S.23.017		Output Fault value 17	
Minimum	-2147483648	Maximum	2147483647
Default	0	Units	
Type	32 Bit User Save	Update Rate	Module reset, EtherNet/IP interface reset or EtherNet/IP interface enable
Display Format	None	Decimal Places	0
Coding	RW, PT		

S.23.018		Output Fault value 18	
Minimum	-2147483648	Maximum	2147483647
Default	0	Units	
Type	32 Bit User Save	Update Rate	Module reset, EtherNet/IP interface reset or EtherNet/IP interface enable
Display Format	None	Decimal Places	0
Coding	RW, PT		

S.23.019		Output Fault value 19	
Minimum	-2147483648	Maximum	2147483647
Default	0	Units	
Type	32 Bit User Save	Update Rate	Module reset, EtherNet/IP interface reset or EtherNet/IP interface enable
Display Format	None	Decimal Places	0
Coding	RW, PT		

S.23.020		Output Fault value 20	
Minimum	-2147483648	Maximum	2147483647
Default	0	Units	
Type	32 Bit User Save	Update Rate	Module reset, EtherNet/IP interface reset or EtherNet/IP interface enable
Display Format	None	Decimal Places	0
Coding	RW, PT		

7 Key features and Protocols

This section details the key features and protocols supported by the onboard Ethernet interface and the SI-Ethernet option module.

7.1 PC/PLC considerations

If the subnet of the host PC/PLC is different to the subnet of the Ethernet interface, then both the Ethernet interface and the PC/PLC, must be configured with the address of a gateway that allows communication between the two devices.

7.2 Modbus TCP/IP

Modbus TCP/IP is one of the most widely supported industrial Ethernet based protocols offering the functionality and simplicity of the Modbus protocol, with the flexibility of Ethernet. Table 7.1 shows the supported Modbus function codes.

Modbus TCP/IP uses the standard Protocol Data Unit (PDU) but without the CRC bytes and encapsulates it within a Modbus TCP/IP Application Data Unit (ADU) for transmission. This means that the Modbus PDU is the same for both standard (RTU) and Ethernet based transmission.

Table 7.1 Supported Modbus function codes

Code	Description
3	Read multiple 16 bit registers.
6	Write single 16 bit register.
16	Write multiple 16 bit registers.
23	Read and write multiple 16 bit registers.

7.2.1 Modbus TCP/IP port

The port number used for Modbus TCP/IP may be reconfigured to a different port number using Pr **S.15.005** as detailed below.

S.15.005		Modbus Listening Port	
Minimum	0	Maximum	65535
Default	502	Units	
Type	16 Bit User Save	Update Rate	MODBUS_THREAD_TICK_TIME
Display Format	None	Decimal Places	0
Coding	RW, BU		

A timer is available to allow a loss of Modbus communication to be managed (see *Modbus Timeout* (**S.15.009**) for more information).

7.2.2 Data structure

Communication between devices is based upon Modbus Application Data Units (ADUs), the ADU consists of 2 parts, the Modbus Application Protocol (MBAP) header and the Modbus Protocol Data Unit (PDU).

Figure 7-1 Modbus Data Structure

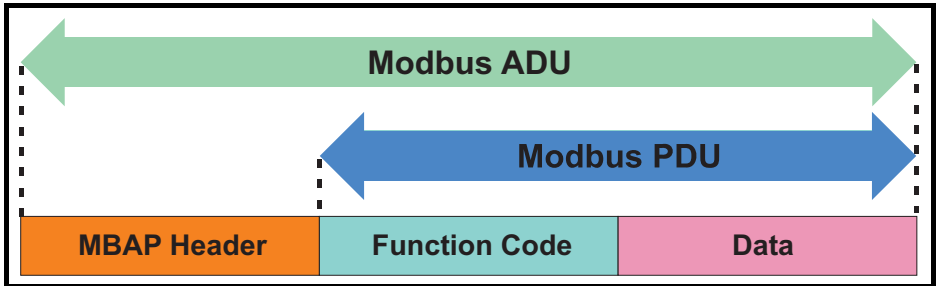

Table 7.2 MBAP Header

Field	Length (Bytes)	Description
Transaction Identifier	2	Uniquely identifies the transaction (0 to 65535)
Protocol Identifier	2	Identifies the protocol (0 = Modbus)
Length	2	Number of following bytes in the message
Unit Identifier	1	Uniquely identifies the destination node (0 to 255)

The unit identifier within the MBAP header is used to identify whether the destination node is the host drive or an option module (not available on the onboard Ethernet interface with firmware versions prior to V01.02.01.10).

Table 7.3 MBAP Unit Identifier

Unit Identifier	Destination
0 or 255	Drive
1	Slot 1
2	Slot 2
3	Slot 3
4	Slot 4 (onboard Ethernet)
254	Self

7.2.3 Data access

Data access using Modbus TCP/IP takes the form of a request for data by the master, followed by a response from the slave indicating success or failure. If no response is received this indicates that the message has not been received or the message is invalid or the node is unable to reply.

Each drive or option module parameter is internally mapped to a single 16-bit Modbus register, all Modbus function codes access 16-bit registers only. To access a 32-bit parameter, two contiguous Modbus registers must be specified in the request and the 32-bit data access scheme must be used.

7.2.4 32-bit data access

Standard Modbus registers are 16 bits in size and reference a single drive/option module parameter. To access a 32-bit data value the multiple read/write services must be used to transfer a contiguous array of 16-bit registers. To instruct the client to select either 16-bit or 32-bit access bit 14 of the register address is used.

NOTE Bit b15 of the register address is reserved for future use.

Figure 7-2 Data type selection

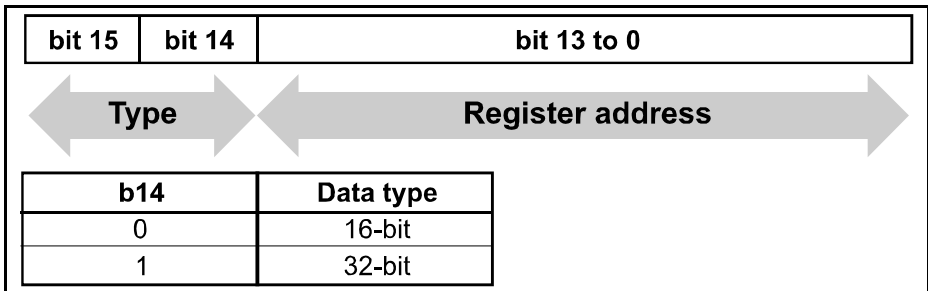

If 32-bit data type is selected then this effectively adds 16384 (0x4000) to the start register address.

e.g. For drive parameter Pr **01.021** in standard addressing mode, the start register value is $16384 + 120 = 16504$ (0x4078)

7.2.5 Supported Modbus function codes

The following table details the supported Modbus function codes.

Table 7.4 Supported Modbus function codes

Function Code		Description
Decimal	Hex (0x)	
3	03	Read multiple 16-bit registers
6	06	Write single 16-bit register
16	10	Write multiple 16-bit registers
23	17	Read and write multiple 16-bit registers

7.2.6 Register addressing

The Modbus register address is 16 bits in size, of which the upper two bits are used for data type selection leaving 14 bits to represent the parameter address, taking into account the slave increments the address value by 1, this results in a theoretical maximum parameter address of 163.84 (limited to 162.99 in software) when the default standard addressing mode (see *Modbus Register Addressing Mode (S.15.013)*) is used.

To access a parameter number above 99 then the modified addressing mode must be used (see *Modbus Register Addressing Mode (S.15.013)*), this will allow access to parameter numbers up to 255 but also limit the maximum menu number to 63.

NOTE A reset is not required to activate the change, the addressing mode is effectively made active immediately on changing.

The Modbus slave device increments the register address by 1 before processing the command, this effectively prevents access to parameter Pr **00.000** in the drive or option module.

The table below shows how the start register address is calculated for both addressing modes.

Table 7.5 Start register addressing

CT Parameter	Addressing mode	Protocol register			
s.mm.ppp	Standard	mm * 100 + ppp - 1			
	Modified	mm * 256 + ppp - 1			
Examples					
		16-bit		32-bit	
		Decimal	Hex (0x)	Decimal	Hex (0x)
0.01.021	Standard	120	00 78	16504	40 78
	Modified	276	01 14	16660	41 14
0.01.000	Standard	99	00 63	16483	40 63
	Modified	255	00 FF	16639	40 FF
3.70.001	Standard	7000	1B 58	23384	5B 58
	Modified	N/A	N/A	N/A	N/A
0.03.161	Standard	N/A	N/A	N/A	N/A
	Modified	928	03 A0	17312	43 A0

7.2.7 FC03 – Read multiple registers

This function code allows a contiguous array of registers to be read. The maximum number of registers that can be read is 120, this allows up to 120 16-bit parameters or 60 32-bit parameters to be read in a single transaction. If this is exceeded the server will issue an exception response code 2.

Master request data

Byte	Description
7	Function code 0x03
8	Start register address (MSB)
9	Start register address (LSB)
10	Number of 16-bit registers (MSB)
11	Number of 16-bit registers (LSB)

Slave response data

Byte	Description
7	Function code 0x03
8	Length of data in read block (Bytes)
9	Register data (MSB)
10	Register data (LSB)

The normal response includes the function code, number of data bytes in the read block followed by the register data (unless an exception occurs).

If 32-bit parameter addressing is used, then for each parameter read:

- Two 16-bit registers must be used in the request
- The register data in the response will contain 4 bytes of data

Example

To read drive parameters **0.20.021** to **0.20.023** (transaction ID = 42) with 32-bit data access and standard addressing:

Master request data

Byte	Hex value	Description
0-1	00 2A	Transaction ID (42)
2-3	00 00	Protocol ID (0=TCP/IP)
4-5	00 06	Length (Bytes=6)
6	FF	Unit identifier (FF= Drive)
7	03	Function code (3)
8-9	47 E4	Start register (20.20)
10-11	00 06	Number of registers (6)

Slave response data

Byte	Hex value	Description
0-1	00 2A	Transaction ID (42)
2-3	00 00	Protocol ID (0=TCP/IP)
4-5	00 0F	Length (Bytes=15)
6	FF	Unit identifier (FF= Drive)
7	03	Function code (3)
8	0C	Data length (Bytes=12)
9-12	?	Pr 0.20.021 data
13-16	?	Pr 0.20.022 data
17-20	?	Pr 0.20.023 data

7.2.8 FC06 – Write single register

This function code writes a single 16-bit value to a register. The normal response is an echo of the request (unless an exception occurs) returned after the parameter has been written.

The register address can be a 32-bit parameter address but only the lower 16 bits of the value will be written.

Master request data

Byte	Description
7	Function code 0x06
8	Start register address (MSB)
9	Start register address (LSB)
10	Register data (MSB)
11	Register data (LSB)

Slave response data

Byte	Description
7	Function code 0x06
8	Start register address (MSB)
9	Start register address (LSB)
10	Register data (MSB)
11	Register data (LSB)

Example

To write the value 12345 to drive parameter **0.20.001** (transaction ID = 42) using standard addressing:

Master request data

Byte	Hex value	Description
0-1	00 2A	Transaction ID (42)
2-3	00 00	Protocol ID (0=TCP/IP)
4-5	00 06	Length (Bytes=6)
6	FF	Unit identifier (FF= Drive)
7	06	Function code (06)
8-9	07 D0	Start register (20.000)
10-11	30 39	Register data (12345)

Slave response data

Byte	Hex value	Description
0-1	00 2A	Transaction ID (42)
2-3	00 00	Protocol ID (0=TCP/IP)
4-5	00 06	Length (Bytes=6)
6	FF	Unit identifier (FF= Drive)
7	06	Function code (6)
8-9	07 D0	Start register (20.000)
10-11	30 39	Register data (12345)

7.2.9 FC16 – Write multiple registers

This function code allows a contiguous series of registers to be written. The maximum number of registers that can be written is 120, this allows up to 120 16-bit parameters or 60 32-bit parameters to be read in a single transaction. If this is exceeded the server will issue an exception response code 2.

The normal response includes the function code, start register address and number of 16-bit registers written (unless an exception occurs), returned after the parameters have been written.

If 32-bit parameter addressing is used, then for each parameter written:

- Two 16-bit registers must be used in the request
- Four bytes must be specified in the request
- The number of registers written in the response will be twice the number of parameters written

Master request data

Byte	Description
7	Function code 0x10
8	Start register address (MSB)
9	Start register address (LSB)
10	Number of 16-bit registers (MSB)
11	Number of 16-bit registers (LSB)
12	Length of register data to write (Bytes)
13	Register data (MSB)
14	Register data (LSB)

Slave response data

Byte	Description
7	Function code 0x10
8	Start register address (MSB)
9	Start register address (LSB)
10	Number of 16-bit registers written (MSB)
11	Number of 16-bit registers written (LSB)

Example

To write the value 12345 to drive parameters **0.20.021** through **0.20.023** (Transaction ID=42) using standard addressing:

Master request data

Byte	Hex value	Description
0-1	00 2A	Transaction ID (42)
2-3	00 00	Protocol ID (0=TCP/IP)
4-5	00 06	Length (Bytes=6)
6	FF	Unit identifier (FF= Drive)
7	10	Function code (16)
8-9	47 E4	Start register (20.020)
10-11	00 06	Number of registers (6)
12	0C	Register data length (Bytes)
13-16	00 00 30 39	Register data 0
17-20	00 00 30 39	Register data 1
21-24	00 00 30 39	Register data 2

Slave response data

Byte	Hex value	Description
0-1	00 2A	Transaction ID (42)
2-3	00 00	Protocol ID (0=TCP/IP)
4-5	00 0F	Length (Bytes=15)
6	FF	Unit identifier (FF= Drive)
7	10	Function code (16)
8-9	47 E4	Start register (20.020)
10-11	00 06	Registers written (6)

7.2.10 FC23 – Read/Write multiple registers

This function code allows a contiguous series of registers to be written and another contiguous series of registers to be read. The maximum number of registers that can be read is 120 and similarly the maximum number of registers that can be written is 120, this allows up to 120 16-bit parameters or 60 32-bit parameters to be read and / or written in a single transaction. If this is exceeded the server will issue an exception response code 2.

Master request data

Byte	Description
7	Function code 0x17
8	Start read register address (MSB)
9	Start read register address (LSB)
10	Number of registers to read (MSB)
11	Number of registers to read (LSB)
12	Start write register address (MSB)
13	Start write register address (LSB)
14	Number of registers to write (MSB)
15	Number of registers to write (LSB)
16	Length of register data to write (Bytes)
17	Register data 0 (MSB)
18	Register data 0 (LSB)

Slave response data

Byte	Description
7	Function code 0x17
8	Length of data in read block (Bytes)
9	Register data (MSB)
10	Register data (LSB)

The normal response includes the function code, number of data bytes in the read block followed by the register data (unless an exception occurs).

If 32-bit parameter addressing is used:

- For each parameter read or written, two 16-bit registers must be used in the request
- For each parameter written, four bytes must be specified in the request
- For each parameter read, four bytes of data will be used in the response

Safety information
Introduction
Mechanical installation
Electrical installation
Getting started
Parameters
Key features and Protocols
PC Applications
Security
Diagnostics
Glossary of terms
Index

Example

To write the value 12345 to drive parameters **0.20.021** through **0.20.023** and read the values of parameters **0.20.024** through **0.20.026** (Transaction ID=42) using standard addressing:

Master request data

Byte	Hex value	Description
0-1	00 2A	Transaction ID (42)
2-3	00 00	Protocol ID (0=TCP/IP)
4-5	00 17	Length (Bytes=6)
6	FF	Unit identifier (FF= Drive)
7	17	Function code (23)
8-9	47 E7	Start read register (0.20.023)
10-11	00 06	Number of read registers (6)
12-13	47 E4	Start write register (0.20.020)
14-15	00 06	Number of write registers (6)
16	0C	Length of register data to write (Bytes=12)
17-20	00 00 30 39	Register data 0 (12345)
21-24	00 00 30 39	Register data 1 (12345)
25-28	00 00 30 39	Register data 2 (12345)

Slave response data

Byte	Hex value	Description
0-1	00 2A	Transaction ID (42)
2-3	00 00	Protocol ID (0=TCP/IP)
4-5	00 0F	Length (Bytes=15)
6	FF	Unit identifier (FF= Drive)
7	17	Function code (23)
8	0C	Length of data (Bytes=12)
9-12	?? ?? ?? ??	Register data 0 (Pr 0.20.024)
13-16	?? ?? ?? ??	Register data 1 (Pr 0.20.025)
17-20	?? ?? ?? ??	Register data 2 (Pr 0.20.026)

7.2.11 Modbus Exception Response Message

If the master request is rejected then an exception response message will be returned.

Exception Response Message

Byte	Hex value	Description
0-1	?? ??	Transaction ID (defined by Modbus Master)
2-3	00 00	Protocol ID
4-5	00 03	Number of data bytes to follow
6	??	Unit identifier
7	??	Function code (request FC with bit b7 set to 1)
8	??	Exception code 01 = Function code not supported 02 = Invalid register address

The master request function code will be returned but with bit b7 set (e.g. function code 0x03 will be returned as 0x83)

7.3 RTMoE (Real Time Motion over Ethernet)

This is a communication protocol developed to support the functionality previously offered by CTNet and CTSync.

RTMoE provides:

- Drive synchronization using the Precision Time Protocol (PTP) otherwise known as IEEE1588 V2
Each PTP device has a tuneable clock running. Following an arbitration process the devices select a master and tune their clocks until they are synchronized to that master. This process may take several seconds to complete.
- Data transfer
 - Cyclic data (synchronous and non-synchronous) is sent using the User Datagram Protocol (UDP)
 - Non-cyclic data is sent using the Transmission Control Protocol (TCP)
- Cycle time down to 500 μ s
- Jitter less than 1 μ s

RTMoE can be configured in two ways:

- Via Machine Control Studio using the cyclic link editor or
- Via parameters using the Easy Mode menus (10 and 11)

The full capabilities of RTMoE are available only when using Machine Control Studio.

Table 7.6 shows the comparison between Easy Mode and Machine Control Studio support levels.

Safety information
Introduction
Mechanical installation
Electrical installation
Getting started
Parameters
Key features and Protocols
PC Applications
Security
Diagnostics
Glossary of terms
Index

Table 7.6 RTMoE Support levels

Capability	Support Level			
	Easy Mode		Machine Control Studio	
	M200-M400	M600-M800	M200-M400	M600-M800
Non-cyclic communication	Yes	Yes	Yes	Yes
Total number of transmit cyclic links	3	3	5	5
Total number of receive cyclic links	3	3	5	5
Max transmit synchronous links	N/A	1	N/A	1
Max receive synchronous links	N/A	1	N/A	1
Max length of non-synchronous link	10 x 32-bit	10 x 32-bit	10 x 32-bit	10 x 32-bit
Max length of synchronous link	N/A	2 x 32-bit	N/A	2 x 32-bit
Minimum transmission period	10 ms	1 ms	10 ms	500 µs
Synchronized with AMC	N/A	Yes (when cycle time >= 1 ms)	N/A	Yes (when cycle time >= 500 µs)
Synchronized with onboard program	N/A	Yes (when cycle time = 4 ms)	N/A	Yes (when cycle time = 4 ms)
Max parameter accesses per second	200	6000	200	6000
Max messages per second (S.02.004)	8000	8000	8000	8000

7.3.1 RTMoE Message rate capability

When designing a network, the message loading for each device should be checked to ensure the number of messages do not exceed the maximum recommended value.

Consider the following example where a Unidrive M700 is communicating with three other devices over Ethernet using Modbus TCP/IP (10 parameters read every 100ms), EtherNet/IP (5 parameters read every 10ms and 5 parameters written every 10ms) and RTMoE (2 parameters written every 500µs).

Protocol	Number of Parameters	Rate	Parameters accessed / second	Message rate / second
Modbus TCP/IP	10 x read	100ms	100	10
EtherNet/IP	5 x read	10ms	500	100
	5 x write	10ms	500	100
RTMoE	2 x write	500µs	4000	2000
Total			5100	2210
Maximum supported			6000	8000
Within capability?			✓	✓

7.3.2 RTMoE Message type

From the system design, it should be known how many drives will be used and what data needs to be sent where. There are two fundamental ways of sharing data:

- Cyclic data – use cyclic links for important information relating to the dynamic behavior of the machine (e.g. control word, speed reference, etc.)
- Non-cyclic data – used for non time-critical information (e.g. drive setup data). A user program must be used to control the transfer of non-cyclic messages. (see *Non cyclic enable (S.02.035)* and *Non cyclic base parameter (S.02.036)*)

Each cyclic message can be one of three types:

1 Unicast – used if data needs to go from one device to another

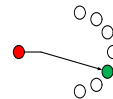

2 Broadcast – used if data needs to go from one device to all other devices

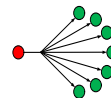

3 Multicast – used if data needs to go from one device to a subset of the other devices

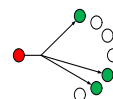

By choosing the most appropriate transmission type an efficient and reliable network can be designed.

For example:

- Three drives must use an ELS (Electronic Line Shaft) to follow a Smart Drive. In this case a **multicast** message should be used to transmit the reference position from the Smart Drive.
- Three drives need to return general status information to the Smart Drive. In this case, each drive should send a **unicast** message to the Smart Drive.
- The Smart Drive needs to command all other drives to stop/start. The Smart Drive should use a broadcast message to transmit the command to all the other drives.

NOTE

Broadcast messages should be used with care, bottlenecks in the network can be easily created by using broadcast messages, this will reduce the performance of the network and, in extreme situations, seriously impair the system operation.

Unicast

A unicast link will only be processed by the specified destination address, the transmitting device specifies the destination address in **S.10.015**, **S.10.025** or **S.10.035** (Tx1, Tx2 or Tx3 respectively) and the receiving link in the relevant device must be set to "Direct" in **S.10.044**, **S.10.054** or **S.10.064** (Rx1, Rx2 or Rx3 respectively).

Multicast

A multicast link can be processed by more than one destination address, the transmitting device configures the multicast address group (Multicast1, Multicast2, Multicast3 or Multicast4) in **S.10.014**, **S.10.024** or **S.10.034** (Tx1, Tx2 or Tx3 respectively), the appropriate multicast destination address is automatically set in **S.10.015**, **S.10.025** or **S.10.035** (Tx1, Tx2 or Tx3 respectively), a receiving link on the same network must be configured to use the same multicast address group as specified in **S.10.014**, **S.10.024** or **S.10.034** (Tx1, Tx2 or Tx3 respectively) in **S.10.044**, **S.10.054** or **S.10.064** (Rx1, Rx2 or Rx3 respectively).

Any device on the same network as the transmitting device may be configured to receive a multicast message.

Each cyclic link can be configured for one of four multicast addresses, this means that on any given network, there may be up to four groups of multicast addresses.

The multicast addresses used are in the local scope addresses ranging from 239.255.0.1 to 239.255.0.4.

Broadcast

A broadcast link can be processed by any device on the network, the transmitting device sets the message type as "Broadcast" in **S.10.014**, **S.10.024** or **S.10.034** (Tx1, Tx2 or Tx3 respectively), the broadcast IP address (255.255.255.255) will be automatically set in **S.10.015**, **S.10.025** or **S.10.035** (Tx1, Tx2 or Tx3 respectively), a receiving link on the same network must be configured to "Direct" in **S.10.044**, **S.10.054** or **S.10.064** (Rx1, Rx2 or Rx3 respectively).

Any device on the same network as the transmitting device may be configured to receive a broadcast message.

7.3.3 Checking for bottlenecks

There are three main reasons why a bottleneck occurs:

1. A drive is receiving more Ethernet messages than it can handle. (8000 frames per second)
2. A drive is being asked to access more parameters than it can handle. (6000 parameters per second for M600, M700 and M800, 500 parameters per second for M200, M300 and M400)
3. A segment of the network has reached it's bandwidth limit.
For a full duplex 100Mbit/sec Ethernet network, assuming all Ethernet messages are the maximum 1500 bytes in length, the bandwidth is 8000 frames/sec in each direction.

NOTE

- It is unrealistic to assume that all messages will be full frames
- In reality the maximum number of frames/sec will be higher
- A more detailed frame analysis may be performed if necessary but the values stated can be used to quickly determine whether bottlenecks could be a problem

7.3.4 RTMoE Message synchronization

Cyclic messages can be synchronized or non-synchronized.

Only one synchronized cyclic link in each direction (one transmit and one receive) is possible so these should only be used for high precision applications where the motion of multiple drives must be closely coupled (e.g. printing applications). All other messages should be sent using a non-synchronized cyclic link.

By default, all cyclic links are non-synchronous, if a synchronous link is required then the relevant link number profile for both the transmit link and receive link must be set to "Sync".

Synchronized cyclic data links utilise the IEEE1588 clock time distributed across the network. The IEEE1588 clock can synchronize the drive's control loops to within a 1µs accuracy, Pr **0.11.002 Option Synchronisation Active** displays the active option slot providing synchronization. With synchronized control loops the Ethernet interface can be used to transfer drive parameters containing motion information, including those from the AMC.

Synchronous links work by including the time of when the data should be used along with the data values. This time allows enough time for the cyclic link to reach all destination devices, the time allowed for can be set in *Easy Mode Maximum Network Delay (S.11.030)*. The receiving interface will wait for its current time to match the timestamp in the cyclic link before processing the message.

With normal Ethernet there are a number of variables that can impact upon the performance of the network. These include:

- Delays through switches - Ethernet is a switched network and messages are typically copied completely into a switch before being forwarded on. *This is fundamental to modern Ethernet and cannot be influenced by system design.*
- Message length – the longer a message, the longer it will take to transmit and copy into a switch before forwarding it on. For a synchronous cyclic link frame this delay is 12µs, for a full Ethernet frame it is 120 µs.
Message length can be controlled, but to maximise compatibility with other Ethernet traffic, it is sensible to allow for full frame Ethernet messages where possible.

- Length of daisy chain - A daisy chain with Ethernet is really a chain of three port switches.
This can be controlled through physical network design e.g. using a tree structure to limit the length of daisy chains.

The above delays (Latency) are managed in software, in conjunction with PTP, to ensure that all device use synchronous data at the same time, but the length of the daisy chain must be controlled by careful network design.

7.3.5 General guidelines for synchronous cyclic data

The following guidelines provide a simple way of specifying a network supporting synchronous cyclic data that offers accurate synchronization and guaranteed determinism, whilst maintaining compatibility with standard Ethernet traffic.

- Limit daisy chains to 10 drives
- Where more than 10 drives are used, create a tree structure using a switch
- Any Ethernet switches must support IEEE1588 V2
- Segregate the network using VLANs and gateways
- Assign one device to be the synchronization master for each segregated network

7.3.6 Segregating the network

If synchronous cyclic links are used, for best reliability it is sensible to segregate the network. This means:

- Assign one (or more) drive(s) to be a gateway, which ensures messages entering the segregated section are stripped of any existing prioritisation information. (See *Gateway Mode (S.02.025)*)
- Ensure that **VLAN** (Virtual Local Area Network) is enabled on all devices so that synchronous data can be prioritised as it is passed between switches. (See *VLAN Enable (S.04.030)* and *Drive VLAN ID (S.04.031)*)
- Use multiple Master Clock Domains. (See *Master Clock Domain (S.11.002)*)

7.3.7 Synchronization master

If a synchronous cyclic link is used then one device must be a synchronous master, if this is an existing 3rd party device then, to minimize the initialization time, all other devices/drives on the network should not be allowed to become the synchronous master. To disable the drive from becoming the synchronous master then set the value in *Preferred Sync Master (S.11.001)* to 0, this ensures the drive does not become the synchronous master.

If there is no existing synchronous master then a suitable drive should be chosen (see *Preferred Sync Master (S.11.001)*), in choosing which drive to be the synchronous master, the physical position of the drives and network layout should be considered so as to minimize the number of switches each message has to pass through.

A typical segregated network using VLANs and gateways consisting of three separate sections of a machine controlled by one master PLC is shown in the following diagram.

Figure 7-3 Typical separately synchronized segregated network

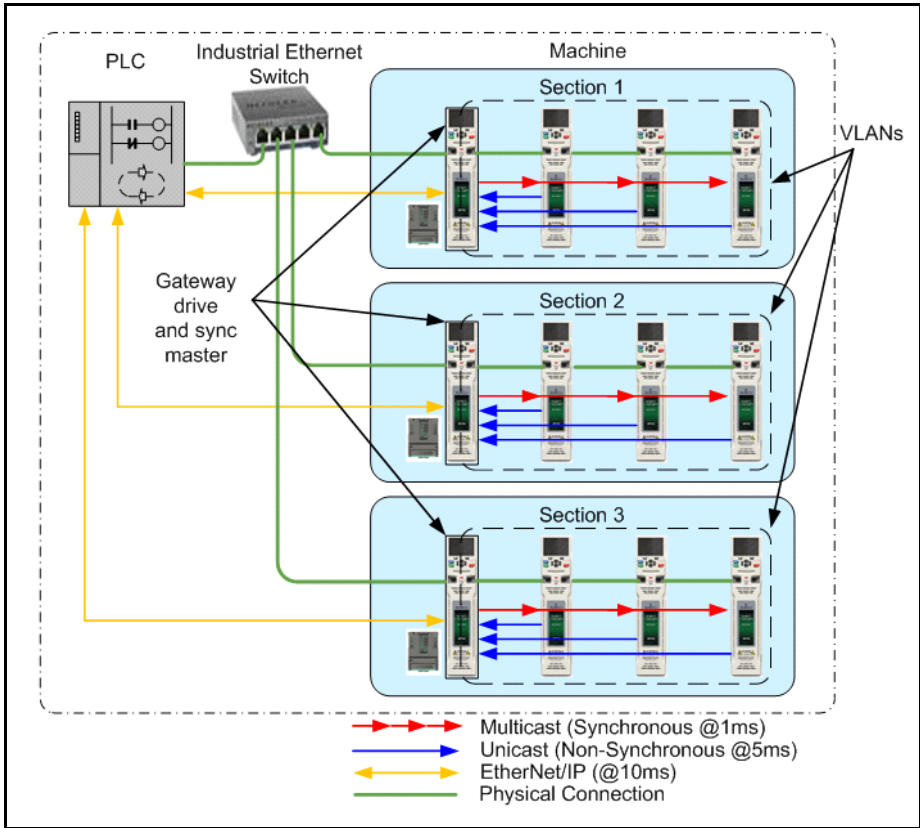

NOTE Configuring a single drive to act as both gateway and synchronization master will increase the message loading on that drive, in some situations this may result in a reduction of the network performance. In these situations, separate drives should be used for the gateway and synchronization master.

Safety information
Introduction
Mechanical installation
Electrical installation
Getting started
Parameters
Key features and protocols
PC Applications
Security
Diagnostics
Glossary of terms
Index

7.3.8 Parameter Mapping Configuration

Each cyclic link (transmit and receive) must have a unique link number (from 1 to 255) to identify it, this link number must be specified in both the transmitting device and receiving device.

For each cyclic link a start parameter and number of consecutive parameters must be defined along with the message type, for a transmit link the destination address (if not a broadcast) and message rate must also be configured. A typical requirement is to transmit and receive parameter values from non-consecutive parameters. This can be performed by configuring a suitable drive menu 0 parameter as the start parameter and the required number of parameters as the count. Drive menu 22 of the drive can be used to configure what parameters the selected drive menu 0 parameters point to.

For example to configure a synchronized cyclic link with control word and speed reference the following parameters would be required:

Transmit Link

Parameter	Description	Value
S.10.010	Tx1 Link Profile	Sync (1)
S.10.011	Tx1 Link Number	1
S.10.012	Tx1 Source Parameter	0.00.060
S.10.013	Tx1 Count	2
S.10.014	Tx1 Transmission Type	Broadcast (1)
S.10.016	Tx1 Message Rate	2 ms
0.22.060	Parameter 00.060 Set-up	6.042
0.22.061	Parameter 00.061 Set-up	1.021

Receive Link

Parameter	Description	Value
S.10.040	Rx1 Link Profile	Sync (1)
S.10.041	Rx1 Link Number	1
S.10.042	Rx1 Destination Parameter	0.00.060
S.10.043	Rx1 Count	2
S.10.044	Rx1 Source Type	Direct (0)
0.22.060	Parameter 00.060 Set-up	6.042
0.22.061	Parameter 00.061 Set-up	1.021

7.3.9 VLANs

To guarantee the timing of synchronous links VLANs must be enabled using *VLAN Enable (S.02.030)*. VLANs include a priority field that is applied to all messages. This field is used to apply a higher priority to synchronous cyclic data than other non-deterministic traffic.

7.3.10 Virtual Master

It is possible to send cyclic data to devices on the network and use the same data on the transmitting device. The cyclic links must be synchronous to include timing information. On the transmitting device a receive link must also be configured with a matching link number to the transmit link. For this link you must set *Rx1 Source Type (S.10.044)* to be *Local*. The Ethernet interface will delay the usage of the data transmitted until the same point in time that all receiving slaves will use the data.

7.3.11 Parameter Update Rate

Parameters are exchanged over the network. The value exchanged over the network must be exchanged with the drive or option parameter. The rate of data exchange differs for synchronous and non-synchronous cyclic links as well as for drive and option destinations.

The diagram below depicts the update cycles used within the Ethernet interface. Cyclic link mappings being exchanged with the drive will be updated at the background task rate. This rate (*Background cycles per second (S.09.008)*) varies with the load on the Ethernet interface; EtherNet/IP data exchange also takes place in the background task.

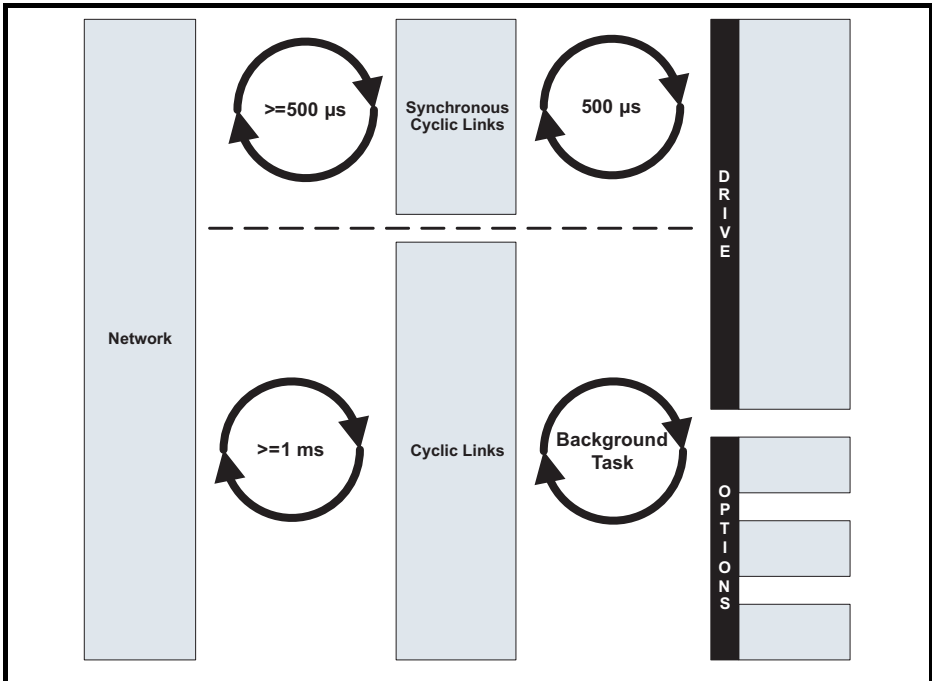

Safety information
Introduction
Mechanical installation
Electrical installation
Getting started
Parameters
Key features and Protocols
PC Applications
Security
Diagnostics
Glossary of terms
Index

7.4 Non-cyclic data access

Unidrive M supports the use of non-cyclic data access by user programs.

By simply enabling non-cyclic data (*Non-cyclic mode enabled (S.02.035)*) and specifying a base parameter (*Non-cyclic base parameter (S.02.036)*), a user program can be used to read or write a parameter either locally in the host drive or option module, or in another drive or option module on the network.

Table 7.7 Non-cyclic data parameter functions

Parameter	Function		Bits
Base address (S.02.036)	Command	0 = No command 1 = Check / Abort 2 = Read one parameter 3 = Write one parameter	0 to 7 (LSB)
	Status	0 = Idle 1 = Ready 2 = Processing 3 = OK 4 = Error	8 to 15 (MSB)
Base address + 1	Destination IP address wwwxxx		0 to 15
Base address + 2	Destination IP address yyyzzz		0 to 15
Base address + 3	Parameter address SMM		0 to 15
Base address + 4	Parameter address PPP		0 to 15
Base address + 5	Parameter value LSW or error code		0 to 15
Base address + 6	Parameter value MSW		0 to 15

The base address specifies the first parameter in a group of seven consecutive parameters that will be used to read from or write to a parameter in the drive or option module at the specified IP address by a user program.

The non-cyclic data access feature operates on a "state machine" principle, this means that the commands must be sent in the correct sequence otherwise the parameter access will fail.

The following diagram illustrates the operation of the non-cyclic parameter access state machine.

Figure 7-4 Non-cyclic parameter access state machine

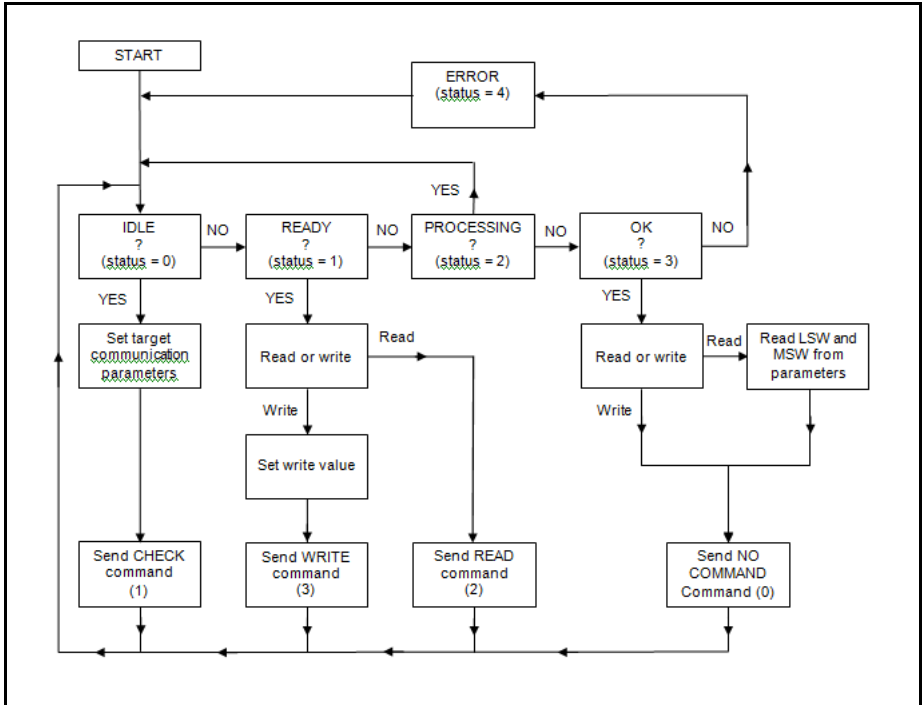

Safety information
Introduction
Mechanical installation
Electrical installation
Getting started
Parameters
Key features and protocols
PC Applications
Security
Diagnostics
Glossary of terms
Index

7.4.1 Setting the destination node IP address

When setting the destination node IP address parameters, each parameter contains two octets of the IP address. i.e. the most significant two octets (www.xxx) of the IP address is written to the base address + 1 parameter and the least significant two octets (yyy.zzz) of the IP address is written to the base address + 2 parameter.

Because each octet is an unsigned byte and the parameter used to store the combined value is a signed 16-bit parameter, the following sequence must be used:

Base address + 1 (www.xxx)

1. "www" – bit shift left 8 times, clear upper 16 bits and lower 8 bits
2. "xxx" – clear upper 24 bits
3. Bitwise OR the two values
4. Correct the result for negative value

Base address + 2 (yyy.zzz)

1. "yyy" – bit shift left 8 times, clear upper 16 bits and lower 8 bits
2. "zzz" – clear upper 24 bits
3. Bitwise OR the two values
4. Correct the result for negative value

As an example, the following code may be used in the user program:

```
// Set the IP address
WWWXXX% = ((www% << 8) & 0x0000FF00) | (xxx% & 0x000000FF)
YYYZZZ% = ((yyy% << 8) & 0x0000FF00) | (zzz% & 0x000000FF)
// Handle the casting from 32bit variable to 16bit parameter
IF WWWXXX% > 32767 THEN
    // Subtract 65536
    WWWXXX% = WWWXXX% - 65536
ENDIF
IF YYYZZZ% > 32767 THEN
    // Subtract 65536
    YYYZZZ% = YYYZZZ% - 65536
ENDIF
```

7.4.2 Setting the destination slot and menu (Base address + 3)

The destination slot and menu address is sent in the format SMM, where S is the slot number and MM is the two digit menu number.

Examples

- For the drive application menu 3, the value sent would be “20”.
- For the SI-Applications Plus register 70 in slot 3, the value sent would be “370”.

NOTE Only menus numbers 0 to 99 are possible using this method.

7.4.3 Setting the destination parameter address (Base address + 4)

The destination parameter address is sent in the format PPP, where PPP is the three digit parameter number.

Examples

- For parameter “021”, the value sent would be “21”.
- For parameter “104”, the value sent would be “104”.

7.4.4 Setting the parameter value to write

The destination parameter value is sent in two signed 16-bit values, therefore it must be converted into two signed 16-bit words.

Base address + 5 (LSW)

The least significant word of the parameter value is converted to a signed 16-bit value stored in a 32-bit variable by bitwise ANDing it with the hexadecimal value 0x00007FFF and subtracting the decimal value 32768 if the result was greater than the decimal value 32767.

Base address + 6 (MSW)

The most significant word of the parameter value is converted to a signed 16-bit value stored in a 32-bit variable by bitwise shifting it 16 places right and bitwise ANDing the result with the hexadecimal value 0x00007FFF, then subtracting the decimal value 32768 if the most significant bit is set to 1.

Examples

Value to write	MSW		LSW	
	Decimal	Hex	Decimal	Hex
3515	0	00000000	3515	00000DBB
123456	1	00000001	-7616	FFFFE240
-123456	-2	FFFFFFFE	7616	00001DC0
-678900	-11	FFFFFFF5	-23540	FFFA40C

As an example, the following code may be used in the user program:

```
// Writing
// Calculate the value to write LSW
LSW% = Value% & 0x00007FFF

// Handle the casting from 32bit variable to 16bit parameter
IF Value%.15 = True% THEN
    // Subtract 32768
    LSW% = LSW% - 32768
ENDIF

// Write it to the correct parameter
Address% = BaseAddress% + 5
#Address% = LSW%

//Calculate the value to write MSW
MSW% = (Value% >> 16) & 0x00007FFF

// Handle the casting from 32bit variable to 16bit parameter
IF Value%.31 = True% THEN
    // Subtract 32768
    MSW% = MSW% - 32768
ENDIF

// Write it to the correct parameter
Address% = BaseAddress% + 6
#Address% = ValueMSW%
```

NOTE BaseAddress% is the parameter specified in **S.02.036**

7.4.5 Reading the parameter value

The required parameter value is read from two signed 16-bit values, these two values must then be correctly merged to form the correct 32-bit value.

Base address + 5 (LSW)

The least significant word of the parameter value is read and converted from a signed 16-bit value and stored in a 32-bit variable, this value is then bitwise ANDed with the hexadecimal value 0x0000FFFF.

If an error is indicated in the status value then this value will identify the cause of the error.

Base address + 6 (MSW)

The most significant word of the parameter value is read and converted from a signed 16-bit value and stored in a 32-bit variable by bitwise shifting it 16 places left and bitwise ANDing the result with the hexadecimal value 0x0000FFFF.

The actual value is then calculated by bitwise ORing the two words together.

If the source parameter was a 16-bit parameter and the most significant bit (b15) was set to 1 (indicating a negative number) then the decimal value 65536 is subtracted.

As an example, the following code may be used in the user program:

```
// Read complete
// Get the LSW value
Address% = BaseAddress% + 5
LSW% = #Address%

// Get the MSW value
Address% = BaseAddress% + 6
MSW% = #Address%

Value% = (LSW% & 0x0000FFFF) | ((MSW% << 16) & 0xFFFF0000)

// Correct for 16bit -ive values
IF Bit32% = 0 THEN
    // 16 bit
    IF Value%.15 = 1 THEN
        // Correct for negative number
        Value% = Value% - 65536
    ENDIF
ENDIF
```

NOTE BaseAddress% is the parameter specified in **S.02.036**.
Bit32% specifies the source parameter as 16-bit or 32-bit (0 = 16-bit. 1 = 32-bit).

Safety information
Introduction
Mechanical installation
Electrical installation
Getting started
Parameters
Key features and Protocols
PC Applications
Security
Diagnostics
Glossary of terms
Index

7.5 EtherNet/IP

The Ethernet interface supports the EtherNet/IP protocol and conforms to the EtherNet/IP adaptation of the Common Industrial Protocol (CIP) Specification. This is the same upper-layer protocol and object model as used in DeviceNet.

The Ethernet interface module will operate as a slave device and the following functionality is supported:

- Variable length input assembly object (instance 100) with consistency for up to 20 parameters
- Variable length output assembly object (instance 101) with consistency for up to 20 parameters
- User selectable RPI timeout action
- Identity object (class 0x01)
- Motor data object (class 0x28)
- Control supervisor object (class 0x29)
- AC/DC Drive object (class 0x2A)
- Control Techniques objects (classes 0x64 to 0x69)
- Explicit (non-cyclic) access to parameters

7.5.1 Requested Packet Interval (RPI) timeout

This timeout is defined by the EtherNet/IP protocol and is configured in the PLC master. If enabled, the Ethernet interface will monitor the data traffic once the cyclic data has been established, and if data is not received within the specified time, it will perform the requested action as defined by Pr **S.20.011** *RPI timeout action*. This indicates that the interface has detected that the cyclic data communication has been interrupted.

NOTE The RPI timeout action will only occur on a loss of cyclic data message, i.e. after cyclic data has been established and subsequently lost. No action will be taken if no cyclic data has been detected.

7.5.2 Read consistency

Under normal conditions, cyclic data is sampled and transmitted at the Requested Packet Interval (RPI). However, if an option module was in the process of modifying the mapped parameters while these parameters were being sampled, then the data transmitted across the network may not be consistent across the entire assembly object. If read consistency is enabled (**S.20.026** *Input assembly object consistency enable*) and a trigger parameter specified in *Input assembly object consistency trigger parameter* (**S.20.027**) then data will only be sampled and transmitted when the trigger parameter *Input assembly object consistency trigger parameter* (**S.20.027**) contains a non-zero value. This trigger parameter will then be set to zero after the data has been sampled.

It is therefore possible, by controlling the trigger parameters, that a user program in the drive or option module can ensure that the values in the cyclic data parameters are not sampled until all values are updated.

Whether consistency is enabled or not, data will always be consistent for an individual parameter, i.e. all 4 bytes of a 32-bit value will be consistent.

7.5.3 Write consistency

Under normal conditions, cyclic data is sampled and written at the Requested Packet Interval (RPI). However, if an option module was in the process of reading the mapped parameters while these parameters were being written, then the data obtained may not be consistent across the entire assembly object. If write consistency is enabled (*Output assembly object consistency enable* (**S.20.028**)) and a trigger parameter specified in *Output assembly object consistency trigger parameter* (**S.20.029**) then new data will only be written to the drive (or option module) when the trigger parameter *Output assembly object consistency trigger parameter* (**S.20.029**) contains a value of zero. This trigger parameter will then be set to one after the data has been written.

It is therefore possible, by controlling the trigger parameters, that a user program in the drive or option module can ensure that the values in the cyclic data parameters are not sampled until all values are updated.

Whether consistency is enabled or not, data will always be consistent for an individual parameter, i.e. all 4 bytes of a 32-bit value will be consistent.

Example

In this example, Pr **0.18.031** is set as the input trigger and Pr **0.18.032** is set as the output trigger. The EtherNet/IP master is configured to check the values of Pr **0.20.011** and Pr **0.20.012** are equal and write the same value to Pr **0.20.021**. The SI-Applications Plus module is configured to generate a ramp value between -32768 and 32767 to write to Pr **0.20.011** and Pr **0.20.012** when the value of Pr **0.20.021** is equal to the ramp value.

With the input and output consistency enabled, parameters Pr **0.20.011** and Pr **0.20.012** will be sampled and transmitted to the EtherNet/IP master when the input trigger parameter Pr **0.18.031** is a non-zero value, Pr **0.20.021** will be written to when the output trigger parameter Pr **0.18.032** is a value of zero.

The parameter changes required are:

S.20.020 <i>Input assembly object size</i>	= 8 (bytes)
S.20.021 <i>Output assembly object size</i>	= 4 (bytes)
S.20.026 <i>In Consistency Enable</i>	= On
S.20.027 <i>In Consistency Trigger Param</i>	= 0.18.031
S.20.028 <i>Out Consistency Enable</i>	= On
S.20.029 <i>Out Consistency Trigger Param</i>	= 0.18.032
S.21.001 <i>Input mapping parameter 1</i>	= 0.20.011
S.21.002 <i>Input mapping parameter 2</i>	= 0.20.012
S.22.001 <i>Output mapping parameter 1</i>	= 0.20.021

Safety information
Introduction
Mechanical installation
Electrical installation
Getting started
Parameters
Key features and Protocols
PC Applications
Security
Diagnostics
Glossary of terms
Index

The user program in the SI-Applications Plus module may be written as follows (some changes may be necessary to account for bus cycle times and parameter update rates):

```
Initial{
    // Initialise variables
    NewValue% = 0
    #86.03 = 0 // Set digital output0 off
    #86.04 = 0 // Set digital output1 off
    #20.011 = 0 // Set input parameter 1 to 0
    #20.012 = 0 // Set input parameter 2 to 0
    #20.021 = 0 // Set output parameter 1 to 0
    REINIT // Initialise configuration
} //Initial

Background{
top:

IF #18.32 = 1 THEN
    // Output trigger set
    // Check first sum value against NewValue
    IF #20.021 = NewValue% THEN
        // OK increment values by 1
        NewValue% = NewValue% + 1
        IF NewValue% > 32767 THEN NewValue = -32768
        #20.011 = NewValue%
        #20.012 = NewValue%

        // Set input trigger – Read input parameters and transmit to master
        #18.031 = 1

        // Delay for PLC to get inputs - depends on cycle time and
parameter access time
        DO WHILE #18.031 = 1
            // Dummy command
            NewValue% = NewValue%
        LOOP

        // Reset output trigger
        #18.032 = 0

        // Delay for outputs to be written - depends on parameter access
time
        DO WHILE #18.032 = 0
            // Dummy command
            NewValue% = NewValue%
        LOOP
    ENDIF
ENDIF
```

```

ELSE
    // ERROR - set DOP0 ON
    #86.03 = 1
ENDIF
ENDIF

```

```

goto top: // main background loop
} //Background

```

7.5.4 Non-cyclic (explicit) data transfer

Non-cyclic or explicit messaging is used to read and write parameters non-cyclically by means of assembly objects. All of the AC Drives profile attributes can be accessed using explicit messaging.

The *Control Techniques* objects provide access to all drive and slot parameters using the following format.

Object	CT Group	CT This Slot	CT Slot 1	CT Slot 2	CT Slot 3	CT Slot 4
Class code	100 (0x64)	101 (0x65)	102 (0x66)	103 (0x67)	104 (0x68)	105 (0x69)
Instance	Menu					
Attribute	Parameter					
Read code	14 (0x0E) Get_Attribute_Single					
Write code	16 (0x10) Set_Attribute_Single					

NOTE An instance value of 0 is not a valid value in this context, therefore an instance value of 200 (0xC8) should be used to access menu 0 parameters. For more information on the *Control Techniques* object see section 7.5.22 *Control Techniques objects* on page 178.

7.5.5 Cyclic (implicit or polled) data transfer

Cyclic data is a method of data transfer that must be setup during network configuration, but is transmitted automatically at the determined rate once configuration is complete.

EtherNet/IP transfers cyclic data using assembly objects, “cyclic data” is sometimes referred to as “Polled data” or “implicit data”.

The terms “input” and “output” refer to data from the perspective of the PLC, an “output” assembly object transfers data from the PLC to the drive, an “input” assembly object transfers data from the drive to the PLC.

NOTE Some PLCs provide the option of transmitting a configuration assembly object. The Ethernet interface does not use a configuration object; if one is required by the PLC then instance 1 should be specified with a length of 0 bytes.

7.5.6 Configuring EtherNet/IP cyclic parameters

In order to use cyclic data over EtherNet/IP, the EtherNet/IP interface must be configured to map the required parameter data to the assembly object.

For drive parameter access, object 100 (0x64) is used for reading parameters and object 101 (0x65) is used for writing parameters. The pre-defined assembly objects as listed in Table 7.8 *Supported drive assembly objects* can also be configured as cyclic data.

7.5.7 Configuring the PLC

Due to the many different makes of PLCs available, the information in this section may not be relevant to all types of PLCs. The information supplied in this section relates to the "ControlLogix" family of controllers supplied by "Allen Bradley".

NOTE Although the Allen Bradley PLCs are mentioned in this document, this does not represent an endorsement of any particular PLC type or PLC manufacturer.

When configuring the PLC for cyclic communication with Unidrive M, the length of each parameter data word and the number of parameters must be specified correctly, Figure 7-5, shows the PLC configuration for 20 input parameters and 20 output parameters, as each parameter consists of 32 bits (4 bytes), the length of each data word should be set to 32 bits (DINT - double integer word).

The length of each data word must normally be configured when the Ethernet module is created within the PLC and can not be changed. If a different length is required then a new Ethernet module must be created.

In order to communicate with the Unidrive M, the PLC must have the Ethernet IP address set correctly as illustrated in Figure 7-5.

Figure 7-5 PLC configuration

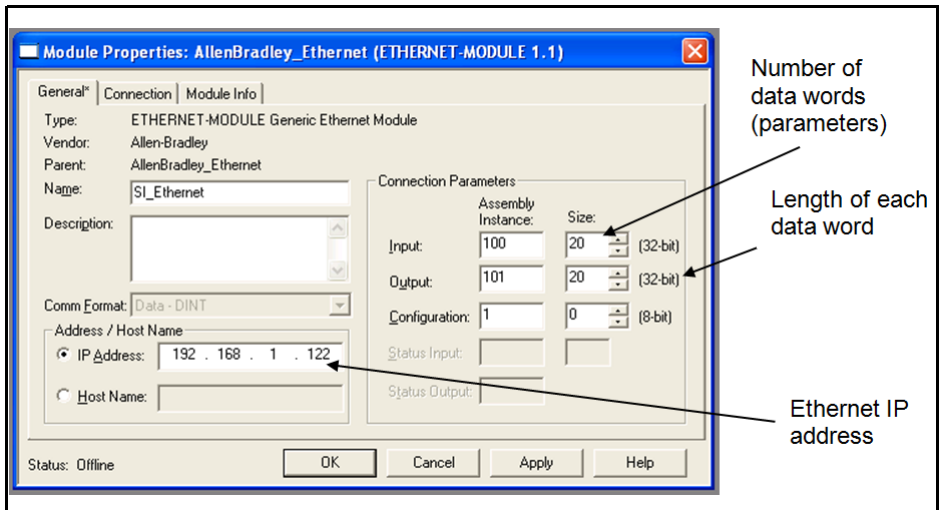

7.5.8 Assembly objects

An assembly object is an object which contains a group of attributes to control or monitor the drive operation. These attributes can be members of EtherNet/IP objects or drive parameters. The Ethernet interface supports a series of standard assembly objects and two *Control Techniques* objects (100 and 101) to access the drive parameters (see Table 7.8 *Supported drive assembly objects* on page 149).

NOTE Conformance with the pre-defined assembly objects specification can only be guaranteed if the speed reference configuration of the drive has not been changed from the default settings. For information on setting default values, refer to the appropriate drive user guide.

Table 7.8 Supported drive assembly objects

Assembly object name	Class		Length (Bytes)	Type	Default Mappings	
	Decimal	Hex (0x)			Bytes 0 to 3	Bytes 4 to 7
PrimaryI	100	64	4 to 80	Input	0.10.040	0.02.001
BscSpdCtrlI	70	46	4	Input		
ExtSpdCtrlI	71	47	4	Input		
SpdTrqCtrlI	72	48	6	Input		
ExtSpdTrqCtrlI	73	49	6	Input		
PrimaryO	101	65	4 to 80	Output	0.06.042	0.01.021
BscSpdCtrlO	20	14	4	Output		
ExtSpdCtrlO	21	15	4	Output		
SpdTrqCtrlO	22	16	6	Output		
ExtSpdTrqCtrlO	23	17	6	Output		

7.5.9 Basic speed control

Output assembly object 0x14 (20₁₀)

The PLC or scanner must be configured for 4 output bytes (or 2 output words) if this assembly object is to be used.

Table 7.9 Basic speed control

Data word	Function
Word 0	Basic control word.
Word 1	Speed reference (<i>SpeedRef</i>).

Basic control word

The basic control word consists of 2 bytes (16 bits), with only 2 bits of the low byte being used as shown below.

b15	b14	b13	b12	b11	b10	b9	b8
b7	b6	b5	b4	b3	b2	b1	b0
					FaultRst		RunFwd

The individual bit functions are described as follows:

Name	Control Word	Description
RunFwd	b0	Set this bit to command the drive to run in the forward direction.
FaultRst	b2	A 0 to 1 transition will reset the drive if the drive was in a trip state.

NOTE For the drive to run at the speed specified in Word 1, Pr **0.06.043** must be *ON* and bit 0, bit 7 and bit 8 of the drive control word (Pr **0.06.042**) must all be set to 1 and the external hardware enable signal must be present.

The individual bit functions for the drive control word are shown in Table 7.10 below.

Table 7.10 Drive control word bit functions

Bit	Function	Equivalent parameter
0	Drive enable	Pr 0.06.015
1	Run forward	Pr 0.06.030
2	Jog forward	Pr 0.06.031
3	Run reverse	Pr 0.06.032
4	Forward/reverse	Pr 0.06.033
5	Run	Pr 0.06.034
6	Not stop	Pr 0.06.039
7	Auto/manual	N/A
8	Analog/preset reference	Pr 0.01.042
9	Jog reverse	Pr 0.06.037
10	Reserved	N/A
11	Reserved	N/A
12	Trip drive	N/A
13	Reset drive	Pr 0.10.033
14	Keypad watchdog	N/A

Speed reference (*SpeedRef*)

The speed reference word utilises 2 bytes (16 bits) as shown below.

b15	b14	b13	b12	b11	b10	b9	b8
SpeedRef (high byte)							
b7	b6	b5	b4	b3	b2	b1	b0
SpeedRef (low byte)							

For more information on the setting of the speed reference see section 7.31 *AC/DC Drive object attributes* on page 174.

7.5.10 Extended speed control

Output assembly object 0x15 (21₁₀)

The PLC or scanner must be configured for 4 output bytes (or 2 output words) if this assembly object is to be used.

Table 7.11 Extended speed control

Data word	Function
Word 0	Extended control word.
Word 1	Speed reference (<i>SpeedRef</i>).

Extended control word

The extended control word consists of 2 bytes (16 bits), with only the low byte used as shown.

b15	b14	b13	b12	b11	b10	b9	b8
b7	b6	b5	b4	b3	b2	b1	b0
	NetRef	NetCtrl			FaultRst	RunRev	RunFwd

The individual bit functions are described as follows:

Name	Control Word	Description
RunFwd	b0	Set this bit to command the drive to run in the forward direction.
RunRev	b1	Set this bit to command the drive to run in the reverse direction.
FaultRst	b2	A 0 to 1 transition will reset the drive if the drive was in a trip state.
NetCtrl	b5	Used in conjunction with Pr 0.06.043 to enable the drive control word bits b0-b6 and bit 9 (Pr 0.06.042).
NetRef	b6	Set this bit to command the drive to use the remote speed reference value specified in Word 1.

NOTE For the drive to run at the speed specified in Word 1, Pr **0.06.043** must be *ON* and bit 0, bit 7 and bit 8 of the drive control word (Pr **0.06.042**) must all be set to 1 and the external hardware enable signal must be present.

NOTE For information on the drive control word see Table 7.10 *Drive control word bit functions* on page 150.

Speed reference (*SpeedRef*)

The speed reference word utilises 2 bytes (16 bits) as shown below.

b15	b14	b13	b12	b11	b10	b9	b8
SpeedRef (high byte)							
b7	b6	b5	b4	b3	b2	b1	b0
SpeedRef (low byte)							

For more information on the setting of the speed reference see section 7.31 AC/DC Drive object attributes on page 174.

7.5.11 Basic speed and torque control

Output assembly object 0x16 (22₁₀)

The PLC or scanner must be configured for 6 output bytes (or 3 output words) if this assembly object is to be used.

Table 7.12 Basic speed and torque control

Data Word	Function
Word 0	Basic control word.
Word 1	Speed reference (<i>SpeedRef</i>).
Word 2	Torque reference (<i>TorqueRef</i>).

Basic control word

The basic control word consists of 2 bytes (16 bits), with only 2 bits of the low byte being used as shown below.

b15	b14	b13	b12	b11	b10	b9	b8
b7	b6	b5	b4	b3	b2	b1	b0
					FaultRst		RunFwd

The individual bit functions are described as follows:

Name	Control Word	Description
RunFwd	b0	Set this bit to command the drive to run in the forward direction.
FaultRst	b2	A 0 to 1 transition will reset the drive if the drive was in a trip state.

NOTE For the drive to run at the speed specified in Word 1, Pr **0.06.043** must be *ON* and bit 0, bit 7 and bit 8 of the drive control word (Pr**0.06.043**) must all be set to 1.

NOTE For information on the drive control word see Table 7.10 *Drive control word bit functions* on page 150.

Speed reference (*SpeedRef*)

The speed reference word utilises 2 bytes (16 bits) as shown below.

b15	b14	b13	b12	b11	b10	b9	b8
SpeedRef (high byte)							
b7	b6	b5	b4	b3	b2	b1	b0
SpeedRef (low byte)							

For more information on the setting of the speed reference see section 7.31 AC/DC Drive object attributes on page 174.

Torque reference (*TorqueRef*)

The torque reference word utilises 2 bytes (16 bits) as shown below.

b15	b14	b13	b12	b11	b10	b9	b8
TorqueRef (high byte)							
b7	b6	b5	b4	b3	b2	b1	b0
TorqueRef (low byte)							

For more information on the setting of the torque reference see section 7.31 *AC/DC Drive object attributes* on page 174.

7.5.12 Extended speed and torque control

Output assembly object 0x17 (23₁₀)

The PLC or scanner must be configured for 6 output bytes (or 3 output words) if this assembly object is to be used.

Table 7.13 Extended speed and torque control

Data word	Function
Word 0	Extended control word.
Word 1	Speed reference (<i>SpeedRef</i>).
Word 2	Torque reference (<i>TorqueRef</i>).

Extended control word

The extended control word consists of 2 bytes (16 bits), with only 5 bits of the low byte used as shown below.

b15	b14	b13	b12	b11	b10	b9	b8
b7	b6	b5	b4	b3	b2	b1	b0
	NetRef	NetCtrl			FaultRst	RunRev	RunFwd

The individual bit functions are described as follows:

Name	Control Word	Description
RunFwd	b0	Set this bit to command the drive to run in the forward direction.
RunRev	b1	Set this bit to command the drive to run in the reverse direction.
FaultRst	b2	A 0 to 1 transition will reset the drive if the drive was in a trip state.
NetCtrl	b5	Used in conjunction with Pr 06.043 to enable the drive control word bits b0-b6 and bit 9 (Pr 06.042).
NetRef	b6	Set this bit to command the drive to use the remote speed reference value specified in Word 1.

NOTE

For the drive to run at the speed specified in Word 1, Pr **06.043** must be ON and bit 0, bit 7 and bit 8 of the drive control word (Pr **06.042**) must all be set to 1 and the external hardware enable signal must be present.

NOTE

For information on the drive control word see Table 7.10 *Drive control word bit functions* on page 150.

Speed reference (*SpeedRef*)

The speed reference word utilises 2 bytes (16 bits) as shown below.

b15	b14	b13	b12	b11	b10	b9	b8
SpeedRef (high byte)							
b7	b6	b5	b4	b3	b2	b1	b0
SpeedRef (low byte)							

For more information on the setting of the speed reference see section 7.31 *AC/DC Drive object attributes* on page 174.

Torque reference (*TorqueRef*)

The torque reference word utilises 2 bytes (16 bits) as shown below.

b15	b14	b13	b12	b11	b10	b9	b8
TorqueRef (high byte)							
b7	b6	b5	b4	b3	b2	b1	b0
TorqueRef (low byte)							

For more information on the setting of the torque reference see section 7.31 *AC/DC Drive object attributes* on page 174.

7.5.13 Basic speed feedback**Input assembly object 0x46 (70₁₀)**

The PLC or scanner must be configured for 4 input bytes (or 2 input words) if this assembly object is to be used.

Table 7.14 Basic speed feedback

Data word	Function
Word 0	Basic status word.
Word 1	Speed feedback (<i>SpeedActual</i>).

Basic status word

The basic status word consists of 2 bytes (16 bits), with only 2 bits of the low byte used as shown below.

b15	b14	b13	b12	b11	b10	b9	b8
b7	b6	b5	b4	b3	b2	b1	b0
					Running1 (Fwd)		Faulted

The individual bit functions are described as follows:

Bit	Name	Description
b0	Faulted	Indicates whether the drive is OK or tripped (0=OK, 1=Tripped).
b2	Running1 (Fwd)	Indicates if the drive is running in the forward direction (0=False, 1=True).

Speed feedback (*SpeedActual*)

The speed feedback word utilises 2 bytes (16 bits) as shown below.

b15	b14	b13	b12	b11	b10	b9	b8
SpeedActual (high byte)							
b7	b6	b5	b4	b3	b2	b1	b0
SpeedActual (low byte)							

For more information on the speed feedback see section 7.31 *AC/DC Drive object attributes* on page 174.

7.5.14 Extended speed feedback

Input assembly object 0x47 (71₁₀)

The PLC or scanner must be configured for 4 input bytes (or 2 input words) if this assembly object is to be used.

Table 7.15 Extended speed feedback

Data word	Function
Word 0	Extended status word.
Word 1	Speed feedback (<i>SpeedActual</i>).

Extended status word

The extended status word consists of 2 bytes (16 bits), with the bits having functions as shown below.

b15	b14	b13	b12	b11	b10	b9	b8
DriveState							
b7	b6	b5	b4	b3	b2	b1	b0
At Reference	RefFrom Net	CtrlFrom Net	Ready	Running2 (Rev)	Running1 (Fwd)	Warning	Faulted

The DriveState byte returns a code to indicate the operating state of the drive as shown in Table 7.16 following.

Safety information
Introduction
Mechanical installation
Electrical installation
Getting started
Parameters
Key features and protocols
PC Applications
Security
Diagnostics
Glossary of terms
Index

Table 7.16 DriveState codes

Code	b15 - b8	State	Description
1	00000001	Startup	This state is skipped over on CT drives.
2	00000010	Not_Ready	Inhibit.
3	00000011	Ready	Ready.
4	00000100	Enabled	Run or Stop.
5	00000101	Stopping	Deceleration or Injection.
6	00000110	Fault_Stop	AC_UU (this will only occur if Mains Loss is enabled).
7	00000111	Faulted	Tripped.
0	00000000	Vendor Specific	All other DriveType states, e.g. Scan, Orienting, Regen Active, etc.

The individual bits of the low byte of the extended status word are described below.

Extended status word (low byte)

Name	Bit	Description
Faulted	b0	Indicates whether the drive is OK or tripped. 0=OK (Pr 0.10.001 =1). 1=Tripped (Pr 0.10.001 =0).
Warning	b1	Indicates if one of the drive alarms is active.
Running1 (Fwd)	b2	Indicates if the drive is running in the forward direction. 0=False, 1=True.
Running2 (Rev)	b3	Indicates if the drive is running in the reverse direction. 0=False, 1=True.
Ready	b4	The 'Ready' bit is set depending on which state the drive is in. Ready = True. Enabled = True. Stopping = True. All others = False.
CtrlFromNet	b5	Indicates if the drive is being controlled from the 'Drive Control Word'. 0=False, 1=True.
RefFromNet	b6	Indicates if the speed reference is derived from Pr 0.01.021 . 0=False (Pr 0.01.050 <>1 OR Pr 0.01.049 <>3). 1=True (Pr 0.01.050 =1 AND Pr 0.01.049 =3).
AtReference	b7	Indicates if the drive speed has reached the set reference. 0=False (Pr 0.10.006 =0). 1=True (Pr 0.10.006 =1).

Speed feedback (*SpeedActual*)

The speed feedback word utilises 2 bytes (16 bits) as shown below.

b15	b14	b13	b12	b11	b10	b9	b8
SpeedActual (high byte)							
b7	b6	b5	b4	b3	b2	b1	b0
SpeedActual (low byte)							

For more information on the speed feedback see section 7.31 *AC/DC Drive object attributes* on page 174.

7.5.15 Basic speed and torque feedback

Input assembly object 0x48 (72₁₀)

The PLC or scanner must be configured for 6 input bytes (or 3 input words) if this assembly object is to be used.

Table 7.17 Basic speed and torque feedback

Data word	Function
Word 0	Basic status word.
Word 1	Speed feedback (<i>SpeedActual</i>).
Word 2	Torque feedback (<i>TorqueActual</i>).

Basic status word

The basic status word consists of 2 bytes (16 bits), with only the low byte used as shown below.

b15	b14	b13	b12	b11	b10	b9	b8
b7	b6	b5	b4	b3	b2	b1	b0
					Running1 (Fwd)		Faulted

The individual bit functions are described as follows:

Bit	Name	Description
b0	Faulted	Indicates whether the drive is OK or tripped (0=OK, 1=Tripped).
b2	Running1 (Fwd)	Indicates if the drive is running in the forward direction (0=False, 1=True).

Speed feedback (*SpeedActual*)

The speed feedback word utilises 2 bytes (16 bits) as shown below.

b15	b14	b13	b12	b11	b10	b9	b8
SpeedActual (high byte)							
b7	b6	b5	b4	b3	b2	b1	b0
SpeedActual (low byte)							

For more information on the speed feedback see section 7.31 *AC/DC Drive object attributes* on page 174.

Torque feedback (*TorqueActual*)

The torque feedback word utilises 2 bytes (16 bits) as shown below.

b15	b14	b13	b12	b11	b10	b9	b8
TorqueActual (high byte)							
b7	b6	b5	b4	b3	b2	b1	b0
TorqueActual (low byte)							

For more information on the torque feedback see section 7.31 *AC/DC Drive object attributes* on page 174.

7.5.16 Extended speed and torque feedback

Input assembly object 0x49 (73₁₀)

The PLC or scanner must be configured for 6 input bytes (or 3 input words) if this assembly object is to be used.

Table 7.18 Basic speed and torque feedback

Data word	Function
Word 0	Extended status word.
Word 1	Speed feedback (<i>SpeedActual</i>).
Word 2	Torque feedback (<i>TorqueActual</i>).

Extended status word

The extended status word consists of 2 bytes (16 bits), with the bits having functions as shown below.

b15	b14	b13	b12	b11	b10	b9	b8
DriveState							
b7	b6	b5	b4	b3	b2	b1	b0
At Reference	RefFrom Net	CtrlFrom Net	Ready	Running2 (Rev)	Running1 (Fwd)	Warning	Faulted

The DriveState byte returns a code to indicate the operating state of the drive as shown in Table 7.19.

Table 7.19 DriveState codes

Code	b15 - b8	State	Description
1	00000001	Startup	This state is skipped over on CT drives.
2	00000010	Not_Ready	Inhibit.
3	00000011	Ready	Ready.
4	00000100	Enabled	Run or Stop.
5	00000101	Stopping	Deceleration or Injection.
6	00000110	Fault_Stop	AC_UU (this will only occur if Mains Loss is enabled).
7	00000111	Faulted	Tripped.
0	00000000	Vendor Specific	All other DriveType states, e.g. Scan, Orienting, Regen Active, etc.

The individual bits of the low byte of the extended status word are described in Table 7.20 *Extended status word (low byte)* on page 159.

Table 7.20 Extended status word (low byte)

Name	Bit	Description
Faulted	b0	Indicates whether the drive is OK or tripped. 0=OK (Pr 0.10.001 =1). 1=Tripped (Pr 0.10.001 =0).
Warning	b1	Indicates if one of the drive alarms is active.
Running1 (Fwd)	b2	Indicates if the drive is running in the forward direction. 0=False, 1=True.
Running2 (Rev)	b3	Indicates if the drive is running in the reverse direction. 0=False, 1=True.
Ready	b4	The 'Ready' bit is set depending on which state the drive is in. Ready = True. Enabled = True. Stopping = True. All others = False.
CtrlFromNet	b5	Indicates if the drive is being controlled from the 'Drive Control Word'. 0=False, 1=True.
RefFromNet	b6	Indicates if the speed reference is derived from Pr 0.01.021 . 0=False (Pr 0.01.050 <>1 OR Pr 0.01.049 <>3). 1=True (Pr 0.01.050 =1 AND Pr 0.01.049 =3).
AtReference	b7	Indicates if the drive speed has reached the set reference. 0=False (Pr 0.10.006 =0). 1=True (Pr 0.10.006 =1).

Safety information
Introduction
Mechanical installation
Electrical installation
Getting started
Parameters
Key features and Protocols
PC Applications
Security
Diagnostics
Glossary of terms
Index

Speed feedback (*SpeedActual*)

The speed feedback word utilises 2 bytes (16 bits) as shown below.

b15	b14	b13	b12	b11	b10	b9	b8
SpeedActual(high byte)							
b7	b6	b5	b4	b3	b2	b1	b0
SpeedActual (low byte)							

For more information on the speed feedback see section 7.31 *AC/DC Drive object attributes* on page 174.

Torque feedback (*TorqueActual*)

The torque feedback word utilises 2 bytes (16 bits) as shown below.

b15	b14	b13	b12	b11	b10	b9	b8
TorqueActual (high byte)							
b7	b6	b5	b4	b3	b2	b1	b0
TorqueActual (low byte)							

For more information on the torque feedback see section 7.31 *AC/DC Drive object attributes* on page 174.

7.5.17 Object Model

The Object Model has the following object classes present.

Table 7.21 Supported Objects

Object Class	Class Code		Number of Instances	Effect
	Decimal	Hex (0x)		
Identity	1	01	1	Provides device specific information.
Assembly	4	04	16	Defines the I/O data format (parameter mapping).
Motor Data	40	28	2	Defines the motor data.
Control Supervisor	41	29	1	Provides drive control and monitoring information.
AC/DC Drive	42	2A	1	Provides drive configuration and running state information.
CT Group	100	64	<No. of menus>	Provides access to drive parameters.
CT This Slot	101	65	<No. of menus>	Provides access to the local option module parameters.
CT Slot 1	102	66	<No. of menus>	Provides access to the option module parameters in slot 1.
CT Slot 2	103	67	<No. of menus>	Provides access to the option module parameters in slot 2.
CT Slot 3	104	68	<No. of menus>	Provides access to the option module parameters in slot 3.
CT Slot 4	105	69	<No. of menus>	Provides access to the onboard Ethernet interface parameters.

7.5.18 Identity object

Class: 0x01 (1₁₀)

The identity object provides identification of and general information about the device.

Table 7.22 Identity object

Attribute	Access	Name	Data Type
1	Get	VendorID	UINT
2	Get	DeviceType	UINT
3	Get	ProductCode	UINT
4	Get	Revision	USINT
6	Get	SerialNumber	UDINT
7	Get	ProductName	SHORT_STRING

Vendor ID

Name:	VendorID		
Class	0x01	Default	0x101 (257 ₁₀)
Instance	0x01	Data Type	UINT
Attribute	0x01	Access	Get

Returns the vendor ID code 0x101 (257₁₀) for *Control Techniques*.

Device type

Name:	DeviceType		
Class	0x01	Default	0x02
Instance	0x01	Data Type	UINT
Attribute	0x02	Access	Get

Returns the device type code. The following codes are used:

Device Type code	Drive type
0x02	AC Drive

Product code

Name:	Product Code		
Class	0x01	Default	See below
Instance	0x01	Data Type	UINT
Attribute	0x03	Access	Get

Returns a 16 bit value to identify the drive type and drive mode and also links a node to the installed EDS files. The product code is calculated as shown in Table 7.23 *Product code bit allocation* below.

Table 7.23 Product code bit allocation

b15	b14	b13	b12	b11	b10	b9	b8	b7	b6	b5	b4	b3	b2	b1	b0
Drive Type					Drive Derivative				Drive Mode			CIP code			

Drive Type (b15 to b11)

The drive type is defined as follows:

Value	Drive Type
2	Unidrive M

Drive Derivative (b10 to b6)

The drive derivative as shown in Pr 0.11.028.

For more information on the drive derivative codes please refer to the relevant drive documentation.

Drive Mode (b5 to b3)

The drive operating mode is defined as follows:

Value	Operating Mode
0	Open-loop
1	RFC-A
2	RFC-S
3	Regen

CIP code (b2 to b0)

The CIP (Common Industrial Protocol) interface code is defined as follows:

Value	Interface ID	Description
0	430	Unidrive M700/800 onboard Ethernet
1	447	SI-DeviceNet
2	310	MCi210
3	433	SI-Ethernet

Revision

Name:	Revision		
Class	0x01	Default	N/A
Instance	0x01	Data Type	ARRAY of USINT
Attribute	0x04	Access	Get

Returns 2 bytes to indicate the major and minor revision numbers of the Ethernet interface firmware version.

The Ethernet interface firmware version (**MM.002**) consists of four 2-digit decimal numbers with the following significance:

[Major].[Minor].[Bugfix].[Build].

The revision code returns the major and minor revisions of the Ethernet interface firmware version in two unsigned bytes, the major revision being returned first followed by the minor revision.

Table 7.24 Revision specification

b7	b6	b5	b4	b3	b2	b1	b0
Major revision (MM.002 / 1000000)							
R	Minor revision (MM.002 / 10000) Mod 100						

Where "Mod 100" refers to the fractional value of the result from **MM.002**/10000, (the value after the decimal point).

e.g. For a value of 12345678 in Pr **MM.002** (12.34.56.78 on the keypad display), the major revision is 12 and the minor revision is 34.

The returned data will consist of 2 unsigned bytes, the first byte will be the major revision value 12 (0x0C) and the second byte will be the minor revision value 34 (0x22).

Major revision

b7	b6	b5	b4	b3	b2	b1	b0
0	0	0	0	1	1	0	0
Major revision = 12 (0x0C)							

Minor revision

b7	b6	b5	b4	b3	b2	b1	b0
R	0	1	0	0	0	1	0
Minor revision = 34 (0x22)							

Serial Number

Name:	SerialNumber		
Class	0x01	Default	N/A
Instance	0x01	Data Type	UDINT
Attribute	0x06	Access	Get

Returns the lower 4 bytes (32 bits) of the Ethernet interface serial number.

The Ethernet interface serial number is contained within two adjacent parameters, Pr **MM.004 Serial Number LS** displays the least 8 significant decimal digits and Pr **MM.005 Serial Number MS** displays the most 8 significant decimal digits.

For example, if the serial number of the onboard Ethernet interface is 123456789 then Pr **MM.005 Serial Number MS** will display 1 and Pr **MM.004 Serial Number LS** will display 23456789.

The Ethernet interface serial number is set during manufacture and cannot be changed.

Product Name

Name:	ProductName			
Class	0x01	Default	Onboard Ethernet	Factory Fitted Ethernet
			SI-Ethernet	SI-Ethernet
Instance	0x01	Data Type	SHORT_STRING	
Attribute	0x07	Access	Get	

Returns the product name as a short string of ASCII Bytes. The first byte specifies the number of following bytes that constitute the product name.

7.5.19 Motor data object

Class: 0x28 (40₁₀)

There are 2 instances of the Motor data object. Instance 1 will represent menu 5 motor information (motor 1) and instance 2 will represent menu 21 motor information (motor 2). The instance being used by the other dependant objects will be determined by Pr **0.11.045**, to use the second motor map objects (instance 2), Pr **0.11.045** should be set to *Motor 2*. Pr **0.11.045** is polled in the background task, so the user should be aware that during motor map changeover, the RPM speed reference may not be accurate. The available attributes and associated functions for the AC motor data object are shown in Table 7.25 *AC Motor data object attributes* below.

Table 7.25 AC Motor data object attributes

AC Motor Instance Attributes			Drive Parameter	
Attribute ID	Name	Access	Instance 1	Instance 2
0x03 (3 ₁₀)	MotorType (*)	Get/Set	None	None
0x06 (6 ₁₀)	RatedCurrent	Get/Set	Pr 0.05.007 (scaled to 100 mA units)	Pr 0.21.007 (scaled to 100 mA units)
0x07 (7 ₁₀)	RatedVoltage	Get/Set	Pr 0.05.009	Pr 0.21.009
0x09 (9 ₁₀)	RatedFreq	Get/Set	Pr 0.05.006 (scaled to Hz)	Pr 0.21.006 (scaled to Hz)
0x0F (15 ₁₀)	BaseSpeed	Get/Set	Pr 0.05.008 (scaled to rpm units)	Pr 0.21.008 (scaled to rpm units)
0x64 (100 ₁₀)	Motor2Select	Get	Pr 0.21.015	Pr 0.21.015
		Set	Pr 0.11.045	Pr 0.11.045

(* The MotorType attribute has no effect on drive operation, it is only used to provide information to the user as shown in Table 7.26 *Supported motor types* below).

Table 7.26 Supported motor types

Value	Motor Type
6	Wound rotor induction motor
7	Squirrel cage induction motor (default)
9	Sinusoidal PM BL motor
10	Trapezoidal PM BL motor

NOTE In Open loop mode, only values 6 and 7 will be supported.

Motor type

Name:	MotorType1		
Class	0x28	Default	7
Instance	0x01	Data Type	USINT
Attribute	0x03	Access	Get/Set

Returns or sets the motor type to be used by the drive for instance 1.

Name:	MotorType2		
Class	0x28	Default	7
Instance	0x02	Data Type	USINT
Attribute	0x03	Access	Get/Set

Returns or sets the motor type to be used by the drive for instance 2.

Rated current

Name:	RatedCurrent1		
Class	0x28	Default	Pr 0.05.007 / 10
Instance	0x01	Data Type	USINT
Attribute	0x06	Access	Get/Set

Returns or sets the rated motor current in Amps for instance 1. This attribute is linked to Pr **0.05.007**.

Set Pr **0.05.007** = RatedCurrent1 * 10.

Get RatedCurrent1 = Pr **0.05.007** / 10.

Name:	RatedCurrent2		
Class	0x28	Default	Pr 0.21.007 / 10
Instance	0x02	Data Type	USINT
Attribute	0x06	Access	Get/Set

Returns or sets the rated motor current in Amps for instance 2. This attribute is linked to Pr **0.21.007**.

Set Pr **0.21.007** = RatedCurrent2 * 10.

Get RatedCurrent2 = Pr **0.21.007** / 10.

Rated voltage

Name:	RatedVoltage1		
Class	0x28	Default	Pr 0.05.009
Instance	0x01	Data Type	USINT
Attribute	0x07	Access	Get/Set

Returns or sets the rated motor voltage in Volts for instance 1. This attribute is linked to Pr **0.05.009**.

Name:	RatedVoltage2		
Class	0x28	Default	Pr 0.21.009
Instance	0x02	Data Type	USINT
Attribute	0x07	Access	Get/Set

Returns or sets the rated motor voltage in Volts for instance 2. This attribute is linked to Pr **0.21.009**.

Rated frequency

Name:	RatedFreq1		
Class	0x28	Default	Pr 0.05.006 / 10
Instance	0x01	Data Type	USINT
Attribute	0x09	Access	Get/Set

Returns or sets the rated motor frequency in Hertz for instance 1. This attribute is linked to Pr **0.05.006**.

Set Pr **0.05.006** = RatedFreq1 * 10.

Get RatedFreq1 = Pr **0.05.006** / 10.

Name:	RatedFreq2		
Class	0x28	Default	Pr 0.21.006 / 10
Instance	0x02	Data Type	USINT
Attribute	0x09	Access	Get/Set

Returns or sets the rated motor frequency in Hertz for instance 2. This attribute is linked to Pr **0.21.006**.

Set Pr **0.21.006** = RatedFreq2 * 10.

Get RatedFreq2 = Pr **0.21.006** / 10.

Safety information
Introduction
Mechanical installation
Electrical installation
Getting started
Parameters
Key features and protocols
PC Applications
Security
Diagnostics
Glossary of terms
Index

Base speed

Name:	BaseSpeed1		
Class	0x28	Default	Pr 0.05.008
Instance	0x01	Data Type	USINT
Attribute	0x0F	Access	Get/Set

Returns or sets the base speed of the motor in RPM for instance 1. This attribute is linked to Pr **0.05.008**.

Name:	BaseSpeed2		
Class	0x28	Default	Pr 0.21.008
Instance	0x02	Data Type	USINT
Attribute	0x0F	Access	Get/Set

Returns or sets the base speed of the motor in RPM for instance 2. This attribute is linked to Pr **0.21.008**.

Motor2Select

Name:	Motor2Select		
Class	0x28	Default	
Instance	0x01	Data Type	USINT
Attribute	0x64	Access	Get/Set

Selects between Motor 1 and Motor 2. This attribute is linked to Pr **0.11.045**. When this bit is set to 1, Motor 2 will be active.

NOTE Any change in this attribute will be implemented when the drive is disabled.

7.5.20 Control Supervisor object

Class: 0x29 (41₁₀)

The Control Supervisor object provides access to various attributes which control or monitor the drive running state. The available attributes and their associated functions are shown in Table 7.27 following.

Table 7.27 Control Supervisor object attribute

Attribute ID		Access	Name	Parameter dependence	
Decimal	Hex (0x)				
3	03	Get/Set	RunFwd		0.06.042 bit1
4	04	Get/Set	RunRev		0.06.042 bit3
5	05	Get/Set	NetCtrl		0.06.042 bit7
6	06	Get	State		See <i>Table 7.28 Control Supervisor state attributes</i> on page 171
7	07	Get	RunningFwd	1	(0.10.040 AND 0x2002) = 0x0002
				0	(0.10.040 AND 0x2002) <> 0x0002
8	08	Get	RunningRev	1	(0.10.040 AND 0x2002) = 0x2002
				0	(0.10.040 AND 0x2002) <> 0x2002
9	09	Get	Ready		See <i>Table 7.28 Control Supervisor state attributes</i> on page 171
10	0A	Get	Faulted		Inverse of 0.10.001
11	0B	Get	Warning		0.10.019
12	0C	Get/Set	FaultRst		Sets 0.10.038 to 100 on a 0 to 1 transition
13	0D	Get	FaultCode		See <i>Table 7.28 Control Supervisor state attributes</i> on page 171
15	0F	Get	CtrlFromNet		0.06.042 bit7 AND 0.06.043
102	66	Get/Set	DriveEnable		0.06.042 bit0

Safety information
Introduction
Mechanical installation
Electrical installation
Getting started
Parameters
Key features and Protocols
PC Applications
Security
Diagnostics
Glossary of terms
Index

RunFwd

Name:	RunFwd		
Class	0x29	Default	N/A
Instance	0x01	Data Type	USINT
Attribute	0x03	Access	Get/Set

Set to 1 to run the drive in the forward direction.

Get/Set Pr **0.06.042** (bit 1).

RunRev

Name:	RunRev		
Class	0x29	Default	N/A
Instance	0x01	Data Type	USINT
Attribute	0x04	Access	Get/Set

Set to 1 to run the drive in the reverse direction.

Get/Set Pr **0.06.042** (bit 3).

NetCtrl

Name:	NetCtrl		
Class	0x29	Default	N/A
Instance	0x01	Data Type	USINT
Attribute	0x05	Access	Get/Set

Switches between terminal and fieldbus control.

Get/Set Pr **0.06.042** (bit 7)

0 = Terminal control.

1 = Fieldbus control.

State

Name:	State		
Class	0x29	Default	N/A
Instance	0x01	Data Type	USINT
Attribute	0x06	Access	Get

This returns a code to indicate the current running state of the drive as shown in Table 7.28 following.

Table 7.28 Control Supervisor state attributes

Code	State	Parameter Dependence	Description
1	Startup	N/A	This state is skipped over
2	Not_Ready	0.10.101 = 0	Inhibit
3	Ready	0.10.101 = 1	Ready
4	Enabled	0.10.101 = 2 OR 0.10.101 = 4	Stop or Run
5	Stopping	0.10.101 = 6 OR 0.10.101 = 7	Decelerating or DC injection braking
6	Fault_Stop	0.10.101 = 5	AC supply loss
7	Faulted	0.10.101 = 9	Tripped
0	Vendor Specific	0.10.101 = All other drive states	See parameter reference guide

RunningFwd

Name:	RunningFwd		
Class	0x29	Default	N/A
Instance	0x01	Data Type	USINT
Attribute	0x07	Access	Get

Indicates that the drive is running in the forward direction.

This attribute will be set to 1 when Pr **0.10.014** = 0 and Pr **0.10.002** = 1.

RunningRev

Name:	RunningRev		
Class	0x29	Default	N/A
Instance	0x01	Data Type	USINT
Attribute	0x08	Access	Get

Indicates that the drive is running in the reverse direction.

This attribute will be set to 1 when Pr **0.10.014** = 0 and Pr **0.10.002** = 1.

Safety information
Introduction
Mechanical installation
Electrical installation
Getting started
Parameters
Key features and protocols
PC Applications
Security
Diagnostics
Glossary of terms
Index

Ready

Name:	Ready		
Class	0x29	Default	N/A
Instance	0x01	Data Type	USINT
Attribute	0x09	Access	Get

The Ready attribute will be set in accordance with the state as shown in Table 7.29 below.

Table 7.29 Control Supervisor Ready attributes

Code	State	Ready state
3	Ready	True
4	Enabled	True
5	Stopping	True
All others		False

Faulted

Name:	Faulted		
Class	0x29	Default	N/A
Instance	0x01	Data Type	USINT
Attribute	0x0A	Access	Get

Indicates that the drive is tripped, i.e. not OK (inverse of Pr **0.10.001**).

Get 1 = Pr **0.10.001** = 0.

Get 0 = Pr **0.10.001** = 1.

Warning

Name:	Warning		
Class	0x29	Default	N/A
Instance	0x01	Data Type	USINT
Attribute	0x0B	Access	Get

Indicates that one of the drive alarms is active.

Get Pr **0.10.019**.

FaultRst

Name:	FaultRst		
Class	0x29	Default	N/A
Instance	0x01	Data Type	USINT
Attribute	0x0C	Access	Get/Set

Resets the drive from a tripped condition.

Sets Pr **0.10.038** to 100 on a 0 to 1 transition.

FaultCode

Name:	FaultCode		
Class	0x29	Default	N/A
Instance	0x01	Data Type	USINT
Attribute	0x0D	Access	Get

The fault code attribute will return the ODVA fault code as follows:

If the drive is not OK, the drive fault code is obtained from Pr **0.10.020**, if the drive fault code is listed in Table 7.30, then the ODVA fault code as shown in Table 7.30 below will be returned.

If the drive fault code is not listed in Table 7.30 then the Ethernet interface will return the ODVA code as follows:

ODVA Fault Code = 0x1000 + drive fault code.

Table 7.30 Control Supervisor fault code attributes

Drive Fault Code	ODVA Fault Code	Drive Fault Code	ODVA Fault Code
1	0x3220	20	0x2310
2	0x3210	21	0x4300
3	0x2300	26	0x5112
4	0x7112	32	0x3130
6	0x9000		

CtrlFromNet

Name:	CtrlFromNet		
Class	0x29	Default	N/A
Instance	0x01	Data Type	USINT
Attribute	0x0F	Access	Get

Indicates whether the drive is operating under fieldbus or terminal control.

This attribute will be set to 1 if Pr **0.06.042** (bit 7) = 1 and Pr **0.06.043** = 1 (fieldbus).

DriveEnable

Name:	DriveEnable		
Class	0x29	Default	N/A
Instance	0x01	Data Type	USINT
Attribute	0x66	Access	Get/Set

Enables the drive. This puts the drive into the "Ready" state, allowing the **RunFwd** and **RunRev** attributes to control the drive. **RunFwd** and **RunRev** will have no effect if **DriveEnable** is not set to 1.

Get/Set Pr **0.06.042** bit 0.

NOTE The external hardware enable signal must also be present before the drive will enter the Ready state.

7.5.21 AC/DC Drive object

Class: 0x2A (42₁₀)

The AC/DC Drive object provides information on the drive running state and supports the following attributes:

Table 7.31 AC/DC Drive object attributes

Attribute ID	Name	Access	Parameter dependence
0x03 (3 ₁₀)	AtReference	Get	Pr 0.10.006
0x04 (4 ₁₀)	NetRef	Get/Set	Pr 0.06.042 (bit 8)
0x06 (6 ₁₀)	DriveMode	Get/Set	(See Table 7.32 on page 175)
0x07 (7 ₁₀)	SpeedActual	Get	Closed Loop Pr 0.03.002
			Open Loop Pr 0.05.004
0x08 (8 ₁₀)	SpeedRef	Get/Set	Closed Loop Pr 0.01.021 (scaled to 0 decimal places)
		Get	Open Loop Pr 0.01.021 * 60 / <i>NofPP</i> (scaled to 0 decimal places)
		Set	Open Loop Pr 0.01.021 = SpeedRef * <i>NofPP</i> / 60 (scaled to 0 decimal places)
0x0B (11 ₁₀)	TorqueActual	Get	Pr 0.04.020 (scaled to 1 decimal place)
0x0C (12 ₁₀)	TorqueRef	Get/Set	Pr 0.04.008 (scaled to 1 decimal place)
0x1D (29 ₁₀)	RefFromNet	Get	1 Pr 0.01.049 =3 AND Pr 0.01.050 =1
			0 Pr 0.01.049 <>3 OR Pr 0.01.050 <>1

NOTE *NofPP* = Number of Pole Pairs.

AtReference

Name:	AtReference		
Class	0x2A	Default	N/A
Instance	0x01	Data Type	USINT
Attribute	0x03	Access	Get

Indicates that the drive is running at the requested speed.

Get Pr **0.10.006**

0 = Drive not running at requested speed.

1 = Drive running at requested speed.

NetRef

Name:	NetRef		
Class	0x2A	Default	N/A
Instance	0x01	Data Type	USINT
Attribute	0x04	Access	Get/Set

Selects the source of the speed reference.

Get/SetPr **0.06.042** bit 8

0 = analog speed reference.

1 = digital speed reference.

NOTE The NetRef can only be changed between local and remote when the drive is configured in speed control mode. If a change is requested when in torque mode then a 'Device State Conflict' error code 0x10 will be returned.

DriveMode

Name:	DriveMode		
Class	0x2A	Default	N/A
Instance	0x01	Data Type	USINT
Attribute	0x06	Access	Get/Set

DriveMode does not allow the operating mode of the drive to be changed. Pr **0.04.011** will be written to as shown in Table 7.32 below, provided that the drive is already in the correct operating mode.

Table 7.32 AC/DC Drive object DriveMode attribute (Get)

Access	DriveMode		Actual Drive Mode	Torque Mode (0.4.011)
	Value	Mode		
Get	1	Open Loop Speed	Open-loop	Speed control mode (0)
			RFC-A	
	2	Closed Loop Speed	RFC-S	
			Open-loop	Torque control (3)
	3	Torque Control	RFC-A	
			RFC-S	
	0	User Defined	Regen	Don't care
			Don't care	Torque control with speed override (2) or Coiler / uncoiler mode (3) or Speed control with torque feed-forward (4)

Table 7.33 AC/DC Drive object DriveMode attribute (Set)

Access	DriveMode		Actual Drive Mode	Action
	Value	Mode		
Set	0	User Defined	Don't care	Return Invalid Attribute Value' (0x09)
	1	Open Loop Speed	Open-loop	Pr 0.04.011 = Speed control mode (0)
			RFC-A or RFC-S or Regen	Return 'Drive state conflict' error (0x10)
	2	Closed Loop Speed	RFC-A or RFC-S	Pr 0.04.011 = Speed control mode (0)
			Open-loop or Regen	Return 'Drive state conflict' error (0x10)
	3	Torque Control	Open-loop or RFC-A or RFC-S	Pr 0.04.011 = Torque control mode (1)
			Regen	Return 'Drive state conflict' error (0x10)

NOTE Pr **0.11.031** will never be changed by setting the DriveMode attribute. An error (0x10) will be generated if the requested DriveMode value does not correspond to the current DriveType operating mode.

SpeedActual

Name:	SpeedActual		
Class	0x2A	Default	N/A
Instance	0x01	Data Type	USINT
Attribute	0x07	Access	Get

Returns the actual speed of the motor in RPM. The source of the motor speed depends on the operating mode of the drive.

Get Pr **0.05.004** (Open Loop).

Get Pr **0.03.002** (Closed Loop).

SpeedRef

Name:	SpeedRef		
Class	0x2A	Default	N/A
Instance	0x01	Data Type	USINT
Attribute	0x08	Access	Get/Set

Sets or returns the speed reference in RPM.

Closed loop

Get/Set SpeedRef = Pr **0.01.021** (Scaled to 0 decimal places).

Open loop

Get SpeedRef = (Pr **0.01.021** * 60) / Pole Pairs (Scaled to 0 decimal places).

Set Pr **0.01.021** = (SpeedRef * Pole Pairs) / 60 (Scaled to 0 decimal places).

TorqueActual

Name:	TorqueActual		
Class	0x2A	Default	N/A
Instance	0x01	Data Type	USINT
Attribute	0x0B	Access	Get

Returns the actual load on the motor as a percentage of the rated motor load. This attribute has 1 decimal place precision, a value of 1000 represents 100.0 % load.

Get Pr **0.04.020** (Scaled to 1 decimal place).

TorqueRef

Name:			
Class	0x2A	Default	N/A
Instance	0x01	Data Type	USINT
Attribute	0x0C	Access	Get/Set

Sets the load (torque) reference as % of rated motor load (torque). This attribute has 1 decimal place precision, so a value of 1000 represents 100.0 % load.

Set Pr **0.04.008** = TorqueRef / 10 (Scaled to 1 decimal place).

Get TorqueRef = Pr **0.04.008** * 10 (Scaled to 1 decimal place).

RefFromNet

Name:	RefFromNet		
Class	0x2A	Default	
Instance	0x01	Data Type	USINT
Attribute	0x1D	Access	Get

Indicates the source of the speed reference.

TRUE if Pr **0.01.049** = 3 and Pr **0.01.050** = 1.

FALSE otherwise.

7.5.22 Control Techniques objects

The Control Techniques objects (classes 0x64 to 0x69) allow access to all drive and option module parameters. The class instance number is used to reference the drive or option module menu number (except menu 0) and the class attribute number references the parameter within that menu.

For example, the drive parameter *Percentage Load* (**0.04.020**) would be accessed as class 0x64, instance 0x04 and attribute 0x14.

An instance value of 0 is invalid therefore to allow access to menu 0 parameters, the instance value 200 (0xC8) must be used.

The number of instances and therefore the number of menus for each class depends on the destination device. If the drive is the destination then the number of menus will depend on the drive operating mode. If the destination is one of the option slots (or onboard Ethernet interface) then the number of menus depends on the type of option module fitted (or the onboard Ethernet interface).

Six individual classes are provided, the following table shows the classes used when accessing the drive or option module parameters.

Table 7.34 Control Techniques object classes

Class Code		Name	Description
Dec	Hex (0x)		
100	64	CT Group	Provides access to all drive parameters
101	65	CT This Slot	Provides access to the connected Ethernet interface parameters
102	66	CT Slot 1	Provides access to the option module in slot 1 parameters
103	67	CT Slot 2	Provides access to the option module in slot 2 parameters
104	68	CT Slot 3	Provides access to the option module in slot 3 parameters
105	69	CT Slot 4	Provides access to the onboard Ethernet interface parameters

8 PC Tools Applications

The Ethernet interface supports the following commissioning and programming software applications:

- Unidrive M Connect
- Machine Control Studio
- CTScope
- SyPTPro
- CT OPC server



Some parameters have a profound effect on the operation of the drive. They must not be altered without careful consideration of the impact on the controlled system. Measures must be taken to prevent unwanted changes due to error or tampering especially if a remote user can access the drive over Ethernet.

8.1 Unidrive M Connect

Unidrive M Connect is the Unidrive M configuration tool for commissioning, optimizing and monitoring the drive or system performance.

Features include:

- Fast task based commissioning and easy maintenance of the Unidrive M family is simplified via familiar Windows interface
- Intuitive graphical tools enhance and simplify user experience
- For experienced users, dynamic drive logic diagrams and enhanced searchable listings are present
- Drive and motor performance can be optimized with minimal specialized drive knowledge
- Tool is scalable to match application requirements
- Supports the import of Unidrive SP parameter files and allows full drive cloning (i.e. parameter sets and application program)
- Multiple simultaneous comms channels for a more complete overview of the system
- Drive discovery gives the ability to find drives on a network automatically without the user having to specify their addresses

For more information on using Unidrive M Connect please refer to the online help supplied.

8.2 Machine Control Studio

Machine Control Studio is a CoDeSys based development environment designed for use with the onboard user program of Unidrive M and the MCI200/MCI210 Machine Controller modules.

Programs can be written in one or more of the supported languages - structured text, function block, SFC (sequential function chart), ladder or instruction list - and downloaded to the onboard programming area on the Unidrive M. The run-time operation of the program can be monitored and the user can interact with the program by setting new values for program variables and drive parameters.

For more information on using Machine Control Studio please refer to the online help supplied.

Safety information
Introduction
Mechanical installation
Electrical installation
Getting started
Parameters
Key features and Protocols
PC Applications
Security
Diagnostics
Glossary of terms
Index

8.3 CTScope

CTScope is a software application which provides commonly used oscilloscope features to monitor drive parameters.

Features include:

- Four channels
- Triggers
 - Start/Stop at absolute time
 - Start/Stop on value (rising/falling edge)
- Channels can capture parameter values from different nodes
- Scaling & offset per channel
- Cursors to aid measurement
- Zoom facility
- Scroll/Panning facility
- Save/load scope configurations with or without data
- Print facility

CTScope was originally developed for use with Unidrive SP, some limitations exist when used with Unidrive M, these limitations include:

- Unidrive M parameter database not supported
- No access to option module parameters (except SI-Applications Plus)
- Only parameters 99 or less can be directly scoped (Parameters with a number of greater than 99 can be mapped to menu 0 and the menu 0 parameter then scoped).

See knowledgebase doc UNIM004 for more information)

8.3.1 Configuration

All the appropriate configuration settings are displayed on the main screen. (CT-TCP/IP must be selected in the Communication Settings).

8.4 SyPTPro

SyPTPro is a complete integrated development suite for distributed drive applications. SyPTPro allows user programs to be developed for multiple nodes in DPL, ladder and function block programming languages. DPL (Drive Programming Language) is a high level language as easy to use as BASIC but optimised for drive applications. SyPTPro also allows user programs to be downloaded to nodes and the runtime operation of the programs to be monitored.

To use SyPTPro over Ethernet requires a version that provides Ethernet support, SyPTPro V02.01.00 or later includes support for TCP/IP.

NOTE SyPTPro can only be used to program a SI-Applications Plus option module and not an onboard drive program or a MCi200/MCi210 Machine Controller module.

For more information on using SyPTPro please refer to the online help supplied.

NOTE SyPTPro is only supported on the onboard Ethernet.

8.5 CT OPC server

OPC is a set of standards written to facilitate connection of a software application such as SCADA and HMI to industrial equipment such as drives and PLCs. Provided such devices have an associated OPC server (inbuilt or external), the standard removes the need for such applications to have any knowledge of how to obtain data from the device. If such applications implement an OPC client they can then obtain data from any devices for which OPC servers exist.

The OPC Data Access specification is based around Microsoft COM & DCOM technology and so servers and clients will typically be running on a Microsoft Operating system. The client and server can both run on the same computer or they can be connected via a standard network such as Ethernet.

The CT OPC server will allow software systems containing an OPC Data Access client to communicate with Unidrive M over Ethernet or Modbus RTU. It does not support any other manufacturers product. The server uses proprietary protocols to gather and distribute data to and from Unidrive M and offers a standard OPC DA interface to OPC Clients.

The CT OPC server supports versions 1, 2 and 3 of the OPC DA server specifications. These specifications are obtainable from the OPC foundation
<http://www.opcfoundation.org>.

NOTE CT OPC server V03.01.00 or later supports TCP/IP over Ethernet.

For more information on using the CT OPC server please refer to the online help supplied.

The CT OPC server was originally developed for use with Unidrive SP, some limitations exist when used with Unidrive M, these limitations include:

- Unidrive M parameter database not supported
- No access to option module parameters (except SI-Applications Plus)
- Only parameters 99 or less can be directly accessed
(Parameters with a number of greater than 99 can be mapped to menu 0 and the menu 0 parameter then accessed).

Safety information
Introduction
Mechanical installation
Electrical installation
Getting started
Parameters
Key features and Protocols
PC Applications
Security
Diagnostics
Glossary of terms
Index

9 Security

9.1 Introduction

On open networked systems it is important that security is considered. Security covers aspects such as access to devices using passwords, network infrastructure, company procedures and backup procedures.

The physical system security should be enforced with acceptable user policies and appropriate employee guidelines.

9.2 General site security issues

9.2.1 Connecting your computer

It is important to remember that when connecting your computer to an existing network you will have an impact on the data and services on that network. Particular care should be taken not to interrupt the flow of data by disconnecting cables, powering down switches/routers, or interrupting data flow by sending large amounts of data over the network.

9.2.2 Virus considerations

Connecting your computer to a network carries the risk of transferring computer viruses to other computers on that network. It is vital that when connecting to a network you ensure that your anti-virus software is up to date and activated. Many operating system vendors offer regular product updates to increase stability and reduce the risk of malicious programs causing damage to your corporate infrastructure.

NOTE The use of a quality anti-virus solution on any networked system is recommended. The overall network security policy resides with the network administrators and any connections to a network should be approved by the network administrators.

9.2.3 Firewall issues

When a high level of security is required between the automation network and the business network a firewall should be used. This helps prevent unwanted traffic passing between the networks and can be used to restrict access to certain machines or users.

NOTE Some managed switches provide control methods for network traffic, however a firewall offers significantly more features. Configuration of a switch or firewall is beyond the scope of this document.

9.3 Default restrictions

By default, all supported protocols are available. This can be changed using the relevant protocol menu.

10 Diagnostics

This section of the manual provides basic diagnostic information intended to enable resolution of the most common problems encountered when setting up the Ethernet interface on an Ethernet network.

A high percentage of problems reported are basic setup problems that can be avoided by using the following pages. Start by using the *Diagnostic flow chart* on page 188 to determine the possible cause of a problem. If after following the flow chart you are still experiencing problems please contact your supplier or local drive supplier for support.

NOTE Please note that support will be limited to the setting up and networking of the drive and not network infrastructure design.

10.1 LED diagnostics

Each Ethernet connection has an associated LED to aid diagnostics, in the case of the onboard Ethernet interface, this LED is mounted below the associated RJ45 connector; the SI-Ethernet option module has two LEDs mounted on the topside of the module (Figure 2-1 *SI-Ethernet* on page 8).

The connection status for the first port (nearest the grounding tab) is indicated by LED "A", and the second port is indicated by LED "B".

The function of these LEDs are described in table 10.1 *LED functionality* below.

Table 10.1 LED functionality

LED State	Description
Off	Ethernet connection not detected.
Steady green	Ethernet connection detected but no data.
Flashing green	Ethernet communication detected and data flow.

10.2 Drive trip display codes

If the Ethernet interface detects an error during operation, it will force a trip on the drive. However, the trip string displayed on the drive will only indicate which slot initiated the trip, if the error originated from the onboard Ethernet interface then the default slot will be 4, however, if the SI-Ethernet option module generated the trip then the slot number will be the slot number the SI-Ethernet option module is fitted to. The exact reason for the trip will be indicated in the drive trip code parameters (Pr **0.10.020** and Pr **0.10.070**).

Table 10.2 *Drive trip indications* on page 184 following shows the possible trips that will be displayed on the drive when a problem is detected or the Ethernet interface initiates a trip.

Table 10.2 Drive trip indications

Trip	Description
SlotX HF	The drive has detected that an Ethernet interface is present but is unable to communicate with it due to a hardware fault.
SlotX Error	User trip generated by the Ethernet interface
SlotX Not Fitted	This trip will occur if a drive slot was previously configured with an option module but on power up, no option module was detected.
SlotX Different	This trip will occur if a drive slot was previously configured with an option module but on power up, a different option module was detected. Replacing the option module with another one of the same ID number will not initiate this trip. The trip will also occur if an option module is installed to a previously unused slot.

10.3 Ethernet sub trip codes

Table 10.3 below shows the possible Ethernet sub trip codes displayed in Pr **0.10.070** and their relevant text strings.

Table 10.3 Ethernet error codes

Value Pr 0.10.070	Sub trip string	Description
100	Link Loss	Network link has been lost
101	E/IP Timeout	An Ethernet/IP RPI timeout trip has occurred
102	E/IP Read Param	Invalid read consistency parameter, is parameter read only?
103	E/IP Write Param	Invalid write consistency parameter, is parameter read only?
104	E/IP Fault	An unexpected Ethernet/IP error has occurred
105	Modbus Timeout	The Modbus connection has timed out
106	Cyclic Timeout	Cyclic Rx link timeout
107	Cyclic RX Late	Cyclic Rx data was received late
108	INIT Switch	Ethernet switch initialization error
109	INIT PTP	IEEE1588 (Precision Time Protocol) initialization error
110	INIT Cyclic	Cyclic data initialization error
111	INIT Modbus	Modbus TCP initialization error
112	INIT SMTP	Email (SMTP) initialization error
113	INIT Ethernet/IP	Ethernet/IP initialization error
114	INIT TCP/IP	TCP/IP initialization error
115	Ethernet Failure	Ethernet controller initialization error
116	E/IP PLC IDLE	Ethernet/IP PLC Idle
117	Sync Task ORun	Synchronous task overrun

Value Pr 0.10.070	Sub trip string	Description
118	INIT Param Chann	Parameter channel Initialization error
119	Link Overload	Too many links to be handled in the same cycle
120	Mcast Over Limit	Too many multicast addresses being used
200	Software Fault	Software Fault
201	BG Overrun	Background task overrun
202	Firmware Invalid	Invalid firmware for hardware version
203	Drive Unknown	Unknown drive type
204	DriveUnsupported	Unsupported drive type
205	Mode Unknown	Unknown drive mode
206	Mode Unsupported	Unsupported drive mode
207	FLASH Error	Corrupted Non-volatile FLASH
208	Database Init	Database initialization error
209	File System Init	File system initialization error
210	Mem Allocation	Memory allocation error
211	Filesystem Error	File system error
212	Config Save	Configuration file save error
213	Over Temperature	Overheated
214	Drive Timeout	The drive has not responded within watchdog period
215	eCMP Comms Error	eCMP communication failure
216	TO eCMP Slot1	eCMP communication to slot 1 timeout
217	TO eCMP Slot2	eCMP communication to slot 2 timeout
218	TO eCMP Slot3	eCMP communication to slot 3 timeout
219	TO eCMP Slot4	eCMP communication to slot 4 timeout
220	I/O Overload	Digital output current demand too high
221	Factory Settings	Missing factory settings
222	Functional Test	Functional test failure
223	Config Restore	Configuration file restore error
224	Self Test Error	Power on self test error
225	Runtime Config	Runtime configuration error
226	Processor except	Processor exception
227	Task Starvation	System task starvation

Safety information
Introduction
Mechanical installation
Electrical installation
Getting started
Parameters
Key features and Protocols
PC Applications
Security
Diagnostics
Glossary of terms
Index

10.4 Ethernet sub trip codes

If the Ethernet interface detects an alarm condition during operation, it will set the appropriate bit in *Active Alarm Bits* **MM.009**. Table 10.4 *Ethernet alarm bits* on page 186 shows the possible conditions.

Table 10.4 Ethernet alarm bits

Bit (Pr MM.009)	Alarm	Description
0	User Program	The user program has generated an alarm
1	eCMP	An eCMP alarm has been generated
2	Modbus	A Modbus alarm has been generated
3	Ethernet/IP	An Ethernet/IP alarm has been generated
4	<i>Reserved</i>	<i>Reserved</i>
5	File System	File system full alarm has been generated
6	Too Hot	Temperature too high alarm has been generated

10.5 Ethernet hardware fault trip codes

If the Ethernet interface detects an internal hardware error, it will force a SlotX.HF (code 250) trip on the drive with an appropriate sub trip string. Table 10.5 shows the possible error codes and sub trip strings.

Table 10.5 Ethernet hardware fault trip codes

Value Pr 0.10.070	Reason
1	The module category cannot be identified
2	All the required customisable menu table information has not been supplied or the tables supplied are corrupt
3	There is insufficient memory available to allocate the comms buffers for this module
4	The module has not indicated that it is running correctly during drive power-up
5	The module has been removed after power-up or it has ceased to indicate to the drive processor that it is still active
6	The module has not indicated that it has stopped accessing drive parameters during a drive mode change
7	The module has failed to acknowledge that a request has been made to reset the drive processor
8	The drive failed to read correctly the menu table from the module during drive power-up
9	The drive failed to upload menu tables from the module and timed-out (5s)
10	Menu table CRC invalid

Recommended actions:

- Ensure the option module is installed correctly.
- Replace the option module.
- Replace the drive.

Safety information	Introduction	Mechanical installation	Electrical installation	Getting started	Parameters	Key features and Protocols	PC Applications	Security	Diagnostics	Glossary of terms	Index
--------------------	--------------	-------------------------	-------------------------	-----------------	------------	----------------------------	-----------------	----------	--------------------	-------------------	-------

10.6 Diagnostic flow chart

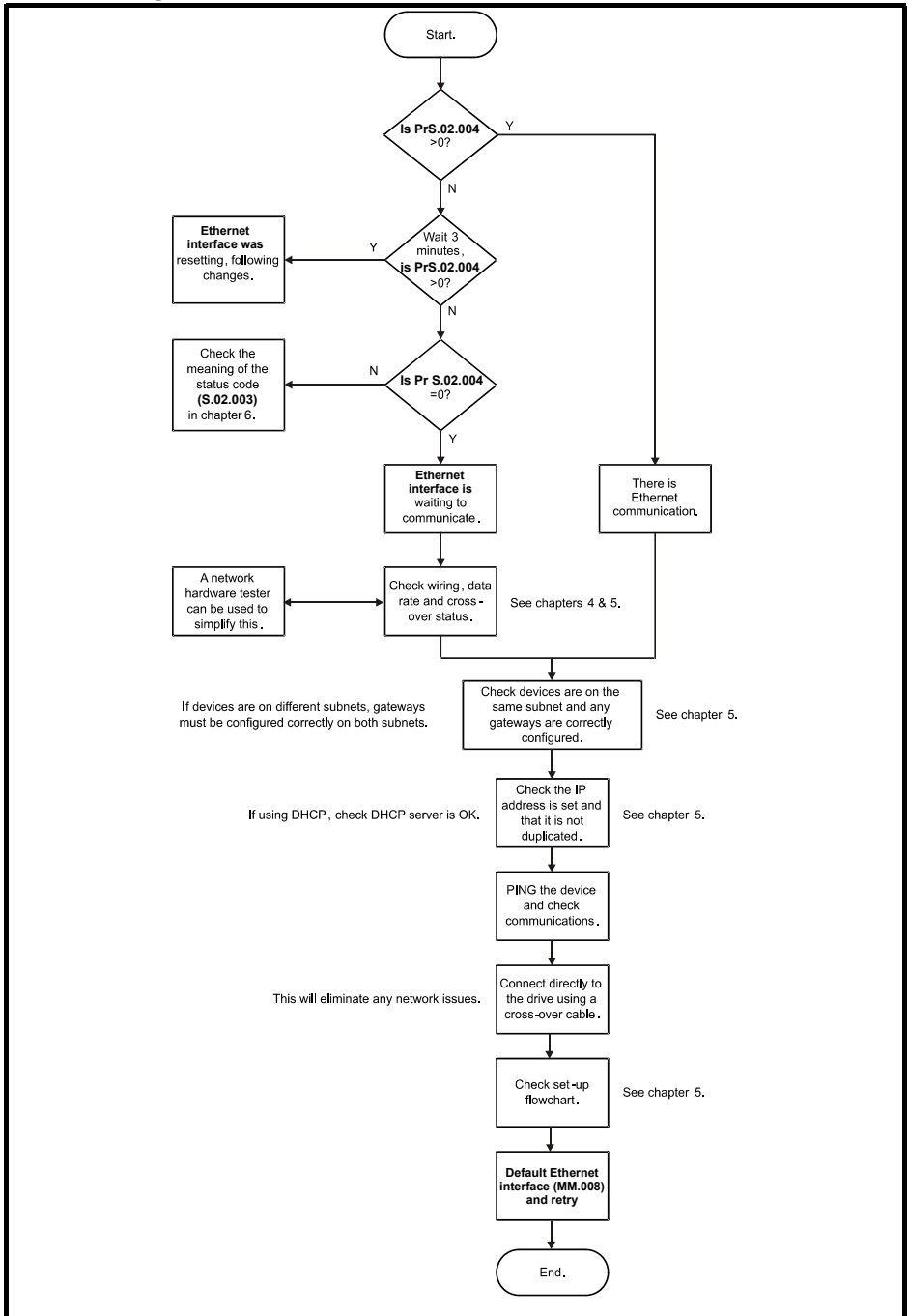

11 Glossary of terms

Address: This is the unique network identification given to a networked device to allow communication on a network. When a device sends or receives data the address is used to determine the source and the destination of the message.

ADU: Application Data Unit. The complete Modbus message frame (ADU) consists of the Modbus Application Protocol (MBAP) and Protocol Data Unit (PDU).

Assembly object: A software component within the Ethernet interface which allows access to the parameters within the drive or which allows control and monitoring of the drive by using the EtherNet/IP protocol.

Attribute: A sub-division of a **Class** which uniquely identifies a specific command.

e.g. The *VendorID* is an attribute of the *Identity object* class.

Used in conjunction with the **Class** and **Instance** properties.

Auto-crossover detection: A method used to automatically detect if a crossover or non-crossover network cable is connected.

Bit: A binary digit, this may have the value of 1 or 0.

Byte: A collection of 8 binary digits that collectively store a value. This may be signed or unsigned.

Class: A collection of properties which allow the control or monitoring of a device. Used in conjunction with the **Instance** and **Attribute** properties.

Consistency: A method of ensuring that the data transferred over the network is transmitted as a single entity, thus preventing data skew when multiple bytes are transmitted.

Control word: A collection of binary digits that are used to control the drive. Features typically include directional controls, run controls and other similar functions.

Crossover lead: A network cable where the terminal connections at one end of the cable are connected straight through to the other end with the exception of the data pair which are transposed. Normally used to connect two network devices together as a separate network.

Safety information
Introduction
Mechanical installation
Electrical installation
Getting started
Parameters
Key features and Protocols
PC Applications
Security
Diagnostics
Glossary of terms
Index

Cyclic (implicit or polled) data: Data that is transmitted at regular intervals over the network. Sometimes referred to as “Implicit data” or “Polled data”.

Data rate: Determines the communication speed of the network, the higher the value the more data can be sent across the network in the same time period.

Device: A piece of equipment connected to a network, this may be any type of equipment including repeaters, hubs, masters or slaves.

DNS: Domain Name Server. This is a server that is used to convert a URL such as “www.controltechniques.com” to an IP address such as 129.254.254.106.

Double word: A 32 bit word, this may be signed or unsigned.

DHCP: Dynamic Host Configuration Protocol. This is a method of allocating IP settings of a node from a central server.

Grounding: Describes the electrical safety or shielding connections for the module.

EDS File: Electronic Data Sheet file. A file which specifies the EtherNet/IP device functionality.

Ethernet address: See *MAC address*.

EtherNet/IP: An industrial application layer protocol for communicating to devices over Ethernet. The EtherNet/IP protocol communicates to the drive using assembly objects.

Exception codes: An error response from Modbus.

Explicit data: See *Non-cyclic data*.

Firewall: A computer or piece of software that restricts connections between different ports. This can be useful when restricting data flow between two network segments.

FTP: File Transfer Protocol. Used for transferring files.

Gateway: A device that allows devices on different subnets or networks to communicate with each other.

Hub: A method of connecting computers together on Ethernet. An un-switched hub will repeat any data received on one port to all ports.

HTTP: Hypertext transfer protocol. This is a document specification protocol. Commonly used in web pages.

Implicit data: See *Cyclic data*.

Instance: A collection of properties (**Attributes**) that are contained within a **Class**. Used in conjunction with the **Class** and **Attribute** properties.

IP: Internet Protocol, this is the protocol used to transmit bytes across an IP network.

IP address: An address that identifies a node uniquely on a subnet or network.

IP subnet: A part of an IP network that consists of a range of addresses that may be accessed by all devices on the same network directly.

LED: Light Emmiting Diode.

Long word: A 32 bit data word that may be signed or unsigned.

LSB: Least Significant Bit/Byte.

MAC address: This is a unique address that is assigned to the Ethernet interface at the time of manufacture. No other device will have this address. The address is used to make connections to the interface before the IP address is assigned.

MBAP: Modbus application protocol. This is a 7 byte header added to the main Modbus telegram (PDU) which contains IP specific identifiers.

Modbus IP: A protocol that allows Modbus to be sent over TCP/IP. The modbus protocol allows manipulation of the parameters within the host drive and option modules.

MSB: Most Significant Bit/Byte.

Node: A device on the network. This may be either a device such as a drive or part of the network such as a repeater.

Safety information
Introduction
Mechanical installation
Electrical installation
Getting started
Parameters
Key features and Protocols
PC Applications
Security
Diagnostics
Glossary of terms
Index

Non-crossover lead: See *Patch lead*.

Non-cyclic (explicit) data: Data that is requested or sent as required and not on a regular basis. Sometimes referred to as “Explicit data”.

Octet: A collection of 8 binary digits which form a byte.

Patch lead: A network cable where the terminal connections at one end of the cable are connected straight through to the other end on a pin to pin basis. Normally used to connect a network device to a network switch.

PC: Personal Computer.

PDU: Protocol Data Unit. This is the main Modbus message telegram, to which is added the MBAP header to form the complete Modbus telegram.

PLC: Programmable Logic Controller.

Poll rate: The rate at which cyclic data is sent and received on the network.

Polled data: See *Cyclic data*.

Router: A device that is used to connect different networks or subnets, in a similar way to a firewall, however a router generally allows significantly less control of the data.

RPI: Requested Packet Interval. Specifies the expected time for the device to respond to a request.

Scan rate: See *Poll rate*.

Shielding: A connection to provide additional immunity to noise used on a network cable.

SMTP: Simple Mail Transfer Protocol. A protocol used for sending email.

SNTP: Simple Network Time Protocol. A protocol used for synchronising time over a network.

Status word: A value that denotes the status of the drive. Each bit within the word will have a specific meaning.

Subnet: A part of a network that has IP addresses in the same range. Devices on the same subnet may communicate directly with other devices on the same subnet without the use of a gateway.

Subnet mask: Defines which part of the IP address constitutes the subnet address and which part constitutes the host device address.

Switch: A device that allows Ethernet devices to be interconnected.

TCP: Transmission Control Protocol, this protocol is responsible for ensuring that the data on the network reaches its destination.

URL: Uniform Resource Locator. A method used to give a web site a friendly name such as *www.controltechniques.com* as an alternative to an IP address.

VPN: Virtual Private Network. A method of using a non-secure or public network that allows devices to be connected together as if they were a part of a private network.

Word: A collection of 16 binary digits.

XML: Extensible Markup Language. A document definition that is intended to transfer data.

Safety information
Introduction
Mechanical installation
Electrical installation
Getting started
Parameters
Key features and Protocols
PC Applications
Security
Diagnostics
Glossary of terms
Index

Index

A

AC/DC Drive object	174
Addressing	15
Addressing etiquette	15
Advanced EDS File	144
Alternative notation	17
Assembly object	148, 189
Attribute	189

B

Basic speed and torque control	152
Basic speed and torque feedback	157
Basic speed control	149
Basic speed feedback	154

C

Cable shield connections	13
Cabling	13
Cabling considerations	12
Cautions	5
Class A addresses	16
Class B addresses	16
Class C addresses	16
Class D & E addresses	16
Class Types	16
Completing the address	17
Compliance	6
Configuring SM-Ethernet cyclic parameters	147
Configuring the PLC	148
Conformance	8
Connection and indications	12
Control Supervisor object	169
Control Techniques object	178
CTSoft	179
Cyclic (implicit or polled) data	190
Cyclic (implicit or polled) data transfer	147

D

Default restrictions	182
DHCP considerations	18
Diagnostic flow chart	188
Diagnostics	183

E

EDS File	190
Electrical installation	12
Electrical safety	5
Environmental limits	5
EtherNet/IP	144, 190
Extended speed and torque control	153

Extended speed and torque feedback	158
Extended speed control	151
Extended speed feedback	155
F	
Firewall issues	182
Fixed IP addressing	18
G	
General safety considerations for remote operation	6
Getting started	15
Glossary of terms	189
Grounding	12
H	
Hubs	13
I	
Installing SyPTPro	180
Instance	191
Introduction	7
IP address	17
L	
Layout	12
LED Diagnostics	183
Length of cable	13
M	
Minimum software versions required for Ethernet	15, 179
Modbus function codes	119
Modbus TCP/IP	119
Module identification	188
Module information	12
Motor	6
N	
Network design	15
Network length	13
Network topology	13
Non-cyclic (explicit) data	192
Non-cyclic (explicit) data transfer	147
O	
Object Class	189
Object Model	161
OPC server	181
P	
Parameters - adjusting	6
PC/PLC considerations	38, 119
Problems	183
Protocols	119
R	
Read consistency	144

Registers	119
Requested Packet Interval (RPI) Timeout Trip	144
Routing	18

S

Safety information	5
Safety of personnel	5
Security	179, 182
Security levels	182
Set-Up Flow Chart	19
Shield	13
Site security	182
SM-LON module - front view	10
SNTP	144
Subnet mask	17
Supported drive assembly objects	148

V

Virus considerations	182
----------------------------	-----

W

Warnings	5
Where do IP addresses come from?	15
Write consistency	145



SCIGATE AUTOMATION (S) PTE LTD

No.1 Bukit Batok Street 22 #01-01 Singapore 659592

Tel: (65) 6561 0488

Fax: (65) 6562 0588

Email: sales@scigate.com.sg

Web: www.scigate.com.sg

Business Hours: Monday - Friday 8.30am - 6.15pm



0478-0137-01